



EQUIPARTS

THAT HARD TO FIND PART IS RIGHT HERE !

"G"

KITCHEN

<i>AERATORS.....</i>	<i>G28-30</i>	<i>MISCELLANEOUS.....</i>	<i>G21</i>
<i>BUMPERS</i>	<i>G37</i>	<i>PRE-RINSE UNITS.....</i>	<i>G2</i>
<i>CAPS</i>	<i>G38</i>	<i>REPAIR PARTS</i>	<i>G12</i>
<i>CHAIR INSERTS.....</i>	<i>G34</i>	<i>SINK FAUCETS</i>	<i>G7-8, 10-11</i>
<i>CHAIR TIPS.....</i>	<i>G33-34</i>	<i>SPOUTS</i>	<i>G24-27</i>
<i>COFFEE URN.....</i>	<i>G20</i>	<i>SPRAY VALVE.....</i>	<i>G3-4</i>
<i>EDLUND CAN OPENER</i>	<i>G19</i>	<i>SPRAY UNITS.....</i>	<i>G6</i>
<i>FILTERS</i>	<i>G22</i>	<i>STRAINERS</i>	<i>G31</i>
<i>GLASS FILLERS.....</i>	<i>G9</i>	<i>T&S REPAIR</i>	<i>G5</i>
<i>GLIDES.....</i>	<i>G32-34, 37-38</i>	<i>TUBULAR.....</i>	<i>G18</i>
<i>KITCHEN REPAIR</i>	<i>G16</i>	<i>TWIST HANDLE WASTE.....</i>	<i>G14</i>
<i>LEVELERS</i>	<i>G35-36</i>	<i>VAPOR PROOF LIGHTING GLOBE ..</i>	<i>G17</i>
<i>LEVER HANDLE WASTE.....</i>	<i>G13,15</i>	<i>VACUUM BREAKERS.....</i>	<i>G23</i>

PRE-RINSE UNITS



1	# 2258	SPRING BODY
2	# 2259	RISER - 24"
3	# 2260	FINGER HOOK
4	# 2261	SCREW
5	# 2160	LEVER HANDLE - HOT
6	# 2161	HOT STEM
7	# 2162	HOT BARREL
8	# 2163	BOTTOM GASKET
9	# 2164	COLD BARREL
10	# 2167	COLD STEM
11	# 2168	TOP GASKET
12	# 2169	BONNET
13	# 2170	PACKING
14	# 2171	PACKING NUT
15	# 2172	LEVER HANDLE - COLD
16	# 2274	WASHER
17	# 2275	NUT
18	# 2276	GASKET

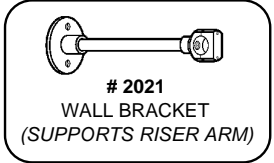
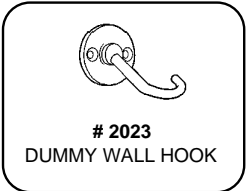
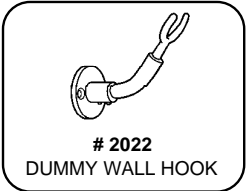
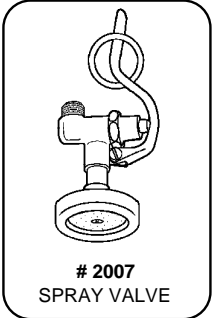
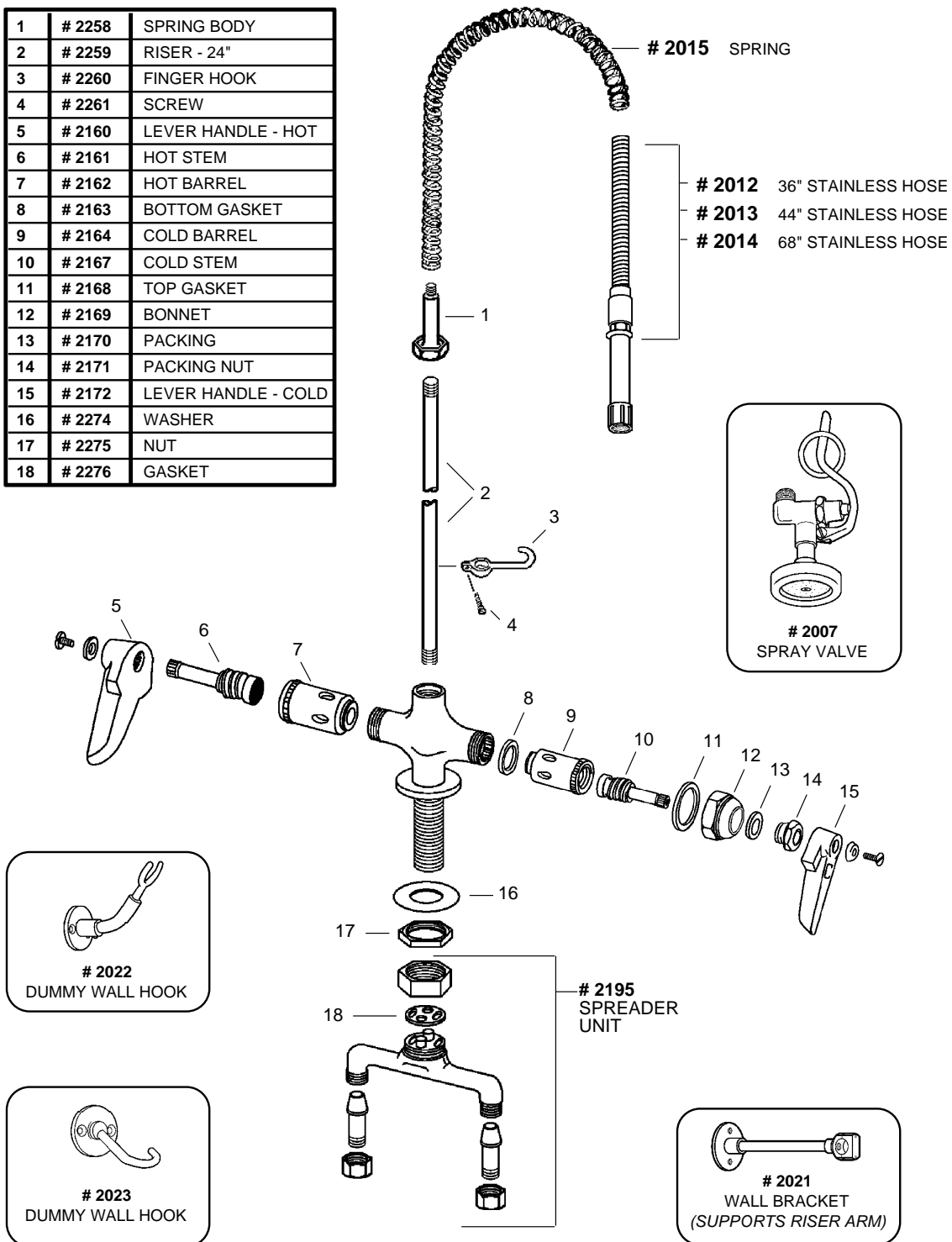

SPRAY VALVES

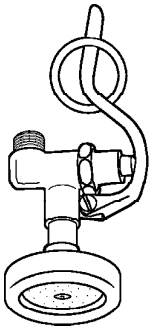

**# 2007
PRE-RINSE SPRAY**



Well constructed and versatile spray head designed especially for heavy duty use in industrial kitchens. Provides a high pressure spray when handle is pressed down and shuts off when handle is released.

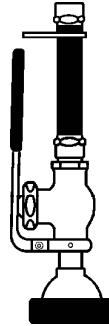

**# 2318
CHICAGO FAUCET
PRE-RINSE SPRAY VALVE**

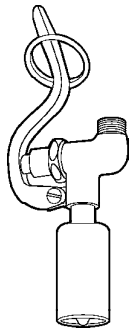

**# 2317
FAN JET PRE-RINSE SPRAY**



Fan jet/knife action spray valve can be used with any T&S pre-rinse assembly in place of # 2007 spray valve ordinarily furnished. Water conserving and energy savings spray effectively rinses dishes, trays, and similar items.

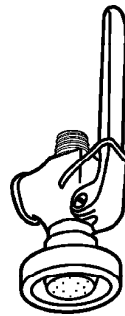

**# 2319
FISHER PRE-RINSE
SPRAY VALVE**

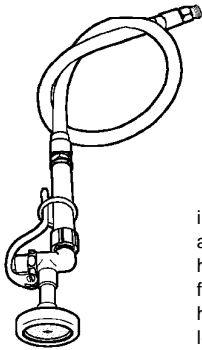

**# 2018
PRE-RINSE SPRAY WITH
FLEXIBLE STAINLESS
STEEL HOSE**



Designed for heavy duty use in industrial kitchens. Consists of automatic shut-off valve with spray head. Ordinarily furnished with a three foot polished flexible stainless steel hose and a 1/2" IPS male inlet. Any length hose supplied upon request



**# 2320
CHG PRE-RINSE
SPRAY VALVE
(IMPORT)**

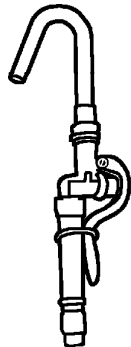

**# 2006
POT FILLER**



Hook nozzle is supplied on this unit in place of the plain nozzle for use on large pots and steam kettles. A retaining ring keeps the valve handle in a compressed position when it is necessary to hook the nozzle on a pot or kettle. This provides a continuous flow of water to fill the container.

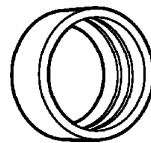

**# 2017
BRUSH ATTACHMENT**

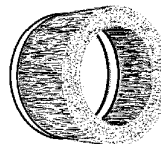

Most existing T & S Spray Assemblies or Pre-Rinse Units may be equipped with brush spray heads. All necessary parts are furnished to make a simple and easy changeover - complete with instructions.

SPRAY VALVE

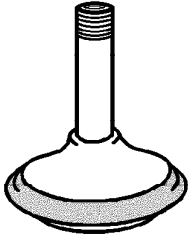

2008
COMPLETE SPRAY HEAD
UNITS SHIPPED WILL HAVE
NEW STYLE RUBBER RING

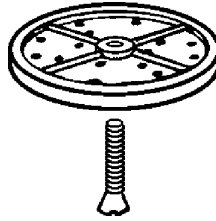

2191
FACE PLATE

55460
SCREW

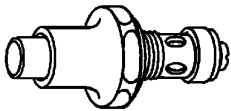

2009
PLUNGER ASSEMBLY
FOR #2007 VALVE

2190
RUBBER RING



OLD STYLE

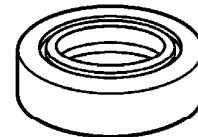

NEW STYLE

STAINLESS STEEL HOSE

- # 2012** 36" LENGTH
- # 2013** 44" LENGTH (MOST COMMON)
- # 2014** 68" LENGTH

LENGTH INCLUDES GREY HANDLE
CUSTOM LENGTHS AVAILABLE ON REQUEST



PRE-RINSE HOSE ADAPTERS

CHROME ADAPTER BUSHINGS FITS T & S PRE-RINSE
HOSE THREAD & CONVERTS TO SIZES BELOW

- # 2220** 1/4" IPS FEMALE **# 2243** 3/8" IPS MALE
- # 2221** 3/8" IPS FEMALE **# 2244** 1/2" IPS MALE
- # 2228** 1/2" IPS FEMALE **# 2245** 3/4" IPS MALE
- # 2232** 3/4" IPS FEMALE **# 2246** G. H. FEMALE

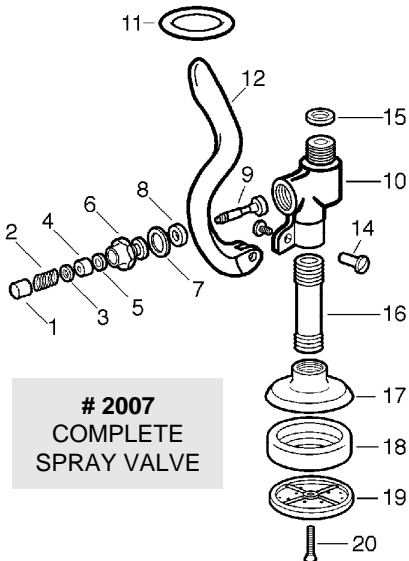

2007
COMPLETE
SPRAY VALVE

2010 REPAIR KIT

- 1 RUBBER RING
- 1 SEAT WASHER
- 1 BINDING WASHER
- 2 BONNET WASHERS
- 2 PACKINGS
- 1 SPRING
- 2 HOSE WASHERS

1	# 2247	PUSH BUTTON	11	# 2273	HOLD-DOWN RING
2	# 2249	BONNET SPRING	12	# 2268	SQUEEZE VALVE HANDLE
3	# 2240	BONNET WASHER	13	# 2263	HANDLE SCREW
4	# 2241	PACKING	14	# 2277	HANDLE NUT
5	# 2254	BONNET WASHER	15	# 2278	HOSE WASHER
6	# 2159	BONNET	16	# 2279	SHORT NIPPLE
7	# 2248	BINDING WASHER	17	# 2280	SPRAY CUP
8	# 2264	SEAT WASHER	18	# 2190	RUBBER RING (NEW STYLE)
9	# 2267	STEM	19	# 2191	SPRAY FACE
10	# 2262	SQUEEZE VALVE BODY	20	# 2283	SPRAY FACE SCREW



T&S REPAIR

SWING SPOUTS

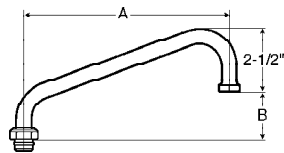

PART#	A	B	PART#	A	B
# 44914	6"	2"	# 2288	14"	4-1/4"
# 2285	8"	2-1/4"	# 44910	16"	5"
# 44915	10"	3"	# 44911	18"	5-3/4"
# 44909	12"	3-3/4"			

DOUBLE JOINTED SWING SPOUTS

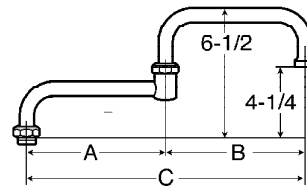

PART#	A	B	C	PART#	A	B	C
# 2291	6"	6"	12"	# 2293	12"	6"	18"
# 2292	9"	6"	15"	# 2294	12"	12"	24"

RIDGID GOOSENECK

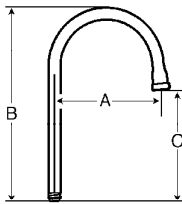

PART#	A	B	C
# 2295	2-3/4"	8"	4-1/2"
# 2296	5-3/4"	9-1/2"	4-1/2"
# 2297	5-3/4"	11-1/2"	6-1/2"
# 2298	5-3/4"	12-1/2"	7-1/2"
# 2299	8-3/4"	10-3/4"	4-1/2"

AVAILABLE WITH VACUUM BREAKER

SWIVEL GOOSENECK

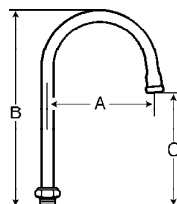

PART#	A	B	C
# 2300	2-3/4"	4-1/2"	2-3/8"
# 2301	2-3/4"	8-3/4"	5-1/8"
# 2302	5-3/4"	8-3/4"	4-3/4"
# 2303	8-3/4"	11-3/4"	5-1/8"

AVAILABLE WITH VACUUM BREAKER

CUSTOM SPOUT TO YOUR SPECIFICATIONS

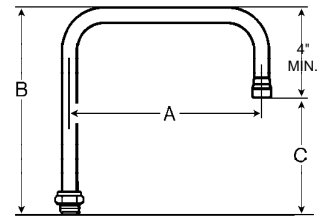

- SPECIFY A, B, C DIMENSIONS
- 3/8" IPS FEMALE OUTLET WITH STREAM REGULATOR REMOVED
- SWIVEL OR 3/8" IPS MALE

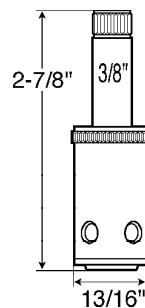
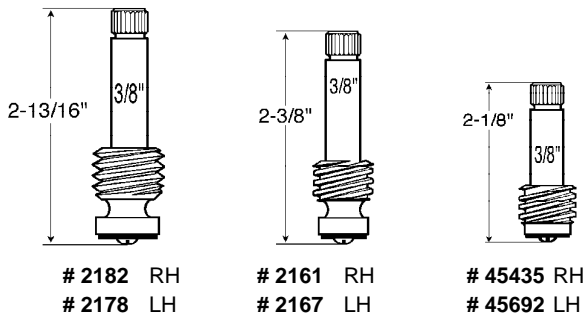

- # 45434 RH ASSEMBLY
- # 2162 RH BARREL ONLY
- # 45691 LH ASSEMBLY
- # 2164 LH BARREL ONLY

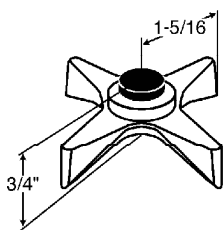

HOT # 46477
COLD # 46478

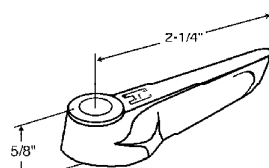

HOT # 2160
COLD # 2172

MASTER PARTS KIT

IN METAL CASE

2304

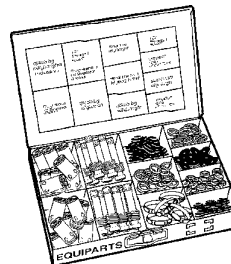

- 2 PACKING NUTS
- 3 INSERTS - HOT
- 3 INSERTS - COLD
- 4 SPINDLES - HOT
- 4 SPINDLES - COLD
- 12 HANDLE SCREWS
- 25 SEAT WASHER SCREWS
- 15 BONNET GASKETS
- 15 SEAT GASKETS
- 25 SWIVEL PIECE "O" RINGS
- 25 SEAT WASHERS
- 15 PACKINGS



SPRAY UNITS

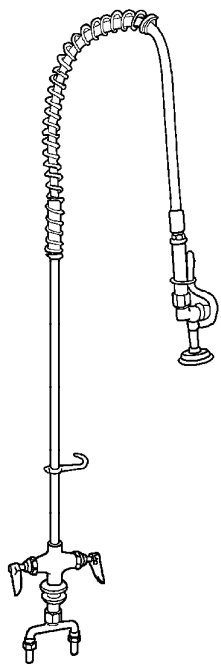

**PRE-RINSE UNIT
2001**

A complete pre-rinse unit with mixing faucet to obtain correct water temperature. Deck type faucet has under-sink 1/4" IPS tailpiece connections on 4" centers. The spring action type gooseneck gives the user a wider range of coverage. Unit is approximately 40" high with an overhang of about 15" with 9" clearance. In normal position, the spray valve hangs approximately 31" below top of the gooseneck spring. Longer length hoses available on request.

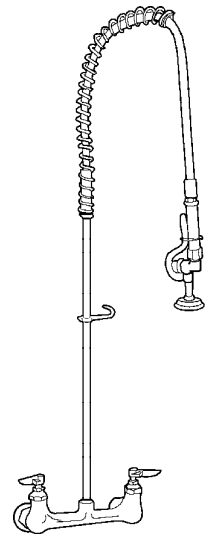

**PRE-RINSE UNIT
2024**

A complete pre-rinse unit with mixing faucet to obtain correct water temperature. Assembly is used where a wall or splash back connection is desired. Recommended where it is necessary to have no obstructions on sink top. Faucet has 8" centers with 1/2" IPS female eccentric flanged union inlets. The spring action type gooseneck gives the user a wider range of coverage. Unit is 34" high with 15" overhang and measures 5" from bottom of spray valve to C/L of faucet. Longer length hoses furnished on request.

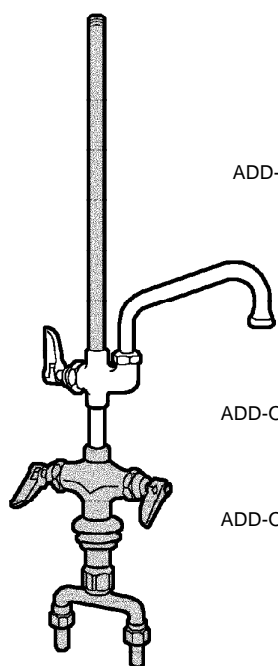

2002
ADD-ON FAUCET FOR USE WITH
PRE-RINSE UNITS
6" NOZZLE

2003
ADD-ON FAUCET WITH 12" NOZZLE

2004
ADD-ON FAUCET WITH 18" NOZZLE

*FITS
3/8 IPS*

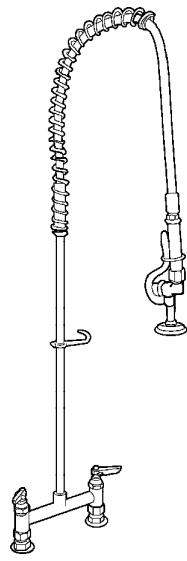

**PRE-RINSE UNIT
2020**

A complete pre-rinse unit with mixing faucet to obtain correct water temperature. Recommended for installations where it is inconvenient to male faucet connections below the sink. 8" center deck faucet with union coupling connections allows faucet to be installed to the piping at sink top level. Faucet has 1/2" IPS female eccentric flanged inlets. Spring action type gooseneck gives the user a wider range of coverage. Unit is 40" high with 15" overhang and 9" clearance. Longer length hoses furnished on request.



SINK FAUCETS

WORKBOARD FAUCET WITH SWING NOZZLE FOR SPLASHBACK MOUNTING

Bronze body with removable seats. High luster chrome plated brass escutcheon 10-1/2" long x 2" wide. Shanks on 8" centers, 1" long, 1/2" NPS thread. Heavy wall tubular swing nozzle.

- # 2305 6" NOZZLE
- # 2306 8" NOZZLE
- # 2307 10" NOZZLE
- # 2308 12" NOZZLE

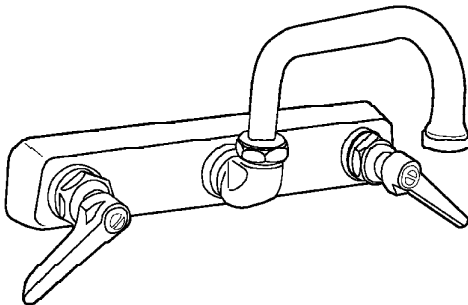

WORKBOARD FAUCET WITH SWING NOZZLE FOR SPLASHBACK MOUNTING

Bronze body with removable seats. High luster chrome plated brass escutcheon 6-1/2" long x 2" wide. Shanks on 3-1/2" centers, 1-1/2" long, 1/2" NPS thread. Heavy wall tubular swing nozzle.

- # 2310 6" NOZZLE
- # 2311 8" NOZZLE
- # 2312 10" NOZZLE
- # 2313 12" NOZZLE

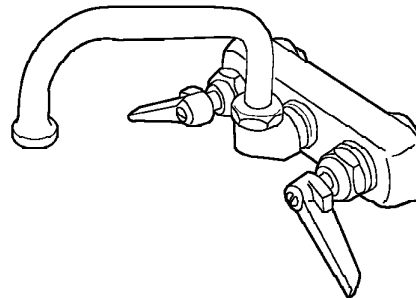

FAUCET WITH SWING NOZZLE AND SPRAY UNIT

2309

Deck mounted mixing faucet has 12" swing nozzle and spray head on flexible stainless steel hose. Vacuum breaker on spray hose line with manual on-off control to spray head. 1/2" IPS female inlets are adjustable from 7-3/4" to 8-1/4" centers. Built-in check valves prevent cross flow of water. Hanger hook holds hose when not in use. Hose and spray is 78" overall. Any length hose and other length nozzles furnished on request.

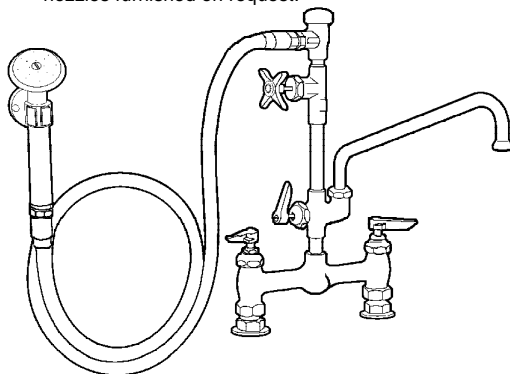

FAUCET WITH SWING NOZZLE AND SPRAY UNIT

2314

Wall mounted mixing faucet has 12" swing nozzle and self closing spray valve on flexible stainless steel hose. 1/2" IPS female inlets are adjustable from 7-3/4" to 8-1/4" centers. Built-in check valves prevent cross flow of water. Hanger hook holds hose when not in use. Hose and spray unit is 108" overall. Any length hose and other length nozzles furnished on request.

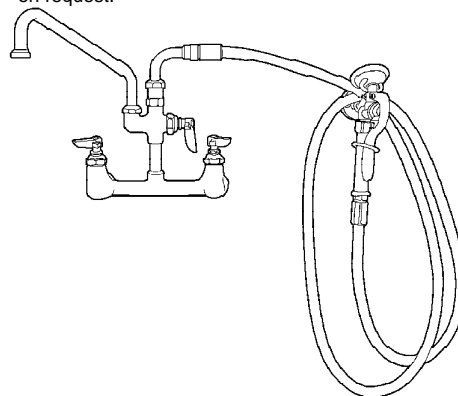

SINK FAUCETS



SINK MIXING FAUCET WITH SWING NOZZLE

8" centers on sink faucet with 1/2" IPS eccentric flanged female inlets. Lever handles.

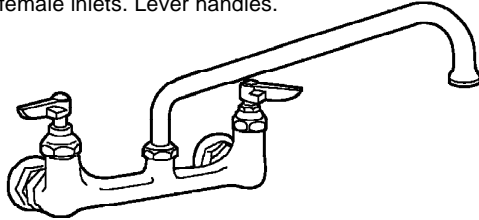

55106

6" SWING NOZZLES

54234

12" SWING NOZZLE

49316

18" SWING NOZZLE

DECK MIXING FAUCET WITH SWING NOZZLE

8" centers on deck faucet with 1/2" IPS eccentric flanged female inlets. Lever handles.

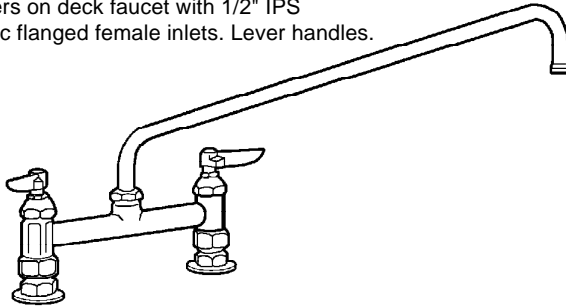

5589

6" SWING NOZZLE

5588

12" SWING NOZZLE

5565

18" SWING NOZZLE

DECK MIXING FAUCET WITH SWING NOZZLE

4" centers with IPS eccentric flanged female inlets. Lever handles.

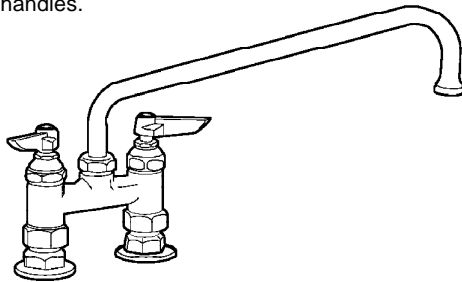

54235

6" SWING NOZZLE

54236

8" SWING NOZZLE

54237

10" SWING NOZZLE

54238

12" SWING NOZZLE

WOK FAUCET FOR ORIENTAL COOKING

Heavy duty range faucet. Wrist action handles.

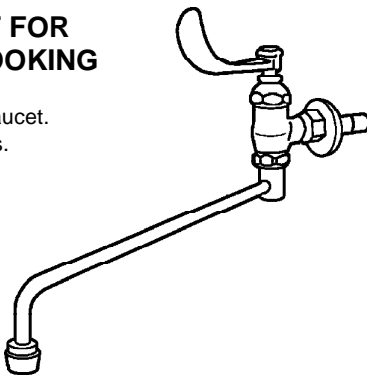

2364

1/2" NPT MALE INLET

2365

1/2" NPT FEMALE INLET

**OTHER STYLES AVAILABLE.
CALL FOR ASSISTANCE !**



GLASS FILLERS

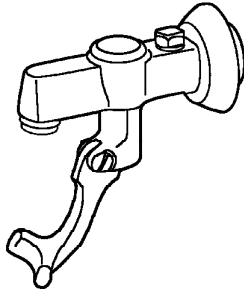

**T & S PUSH BACK GLASS FILLER
2025**

Heavy duty construction. Wall mounted, 3/8 IPS female inlet with adjustable flange. Volume regulator. Center of outlet to wall - 3-3/4". Translucent blue Lexan push back arm. Instantaneous shut off.

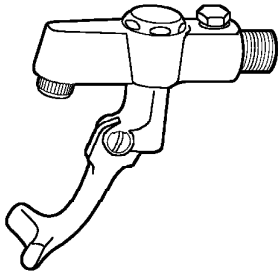

**T & S PUSH BACK GLASS FILLER
2027**

Heavy duty construction. Wall mounted, 3/8 IPS male inlet. Volume regulator. Center of outlet to inlet - 3-1/2". Translucent blue Lexan push back arm. Instantaneous shut off.

2028
1/2" IPS male inlet

2029
With adjustable flange. Center of outlet to inlet - 4-3/4"

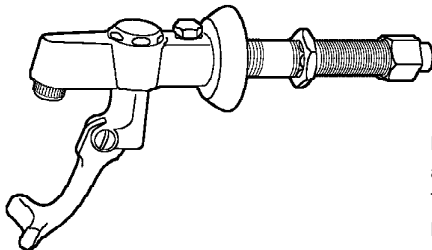

**T & S PUSH BACK GLASS FILLER
2026**

Heavy duty construction. Wall mounted, 3/8 IPS female inlet with adjustable flange. Volume regulator. Center of outlet to wall - 3-3/4". Translucent blue Lexan push back arm. Instantaneous shut off. Male shank and coupling for block tin pipe, 1/4". Fits cabinets up to 2-1/4" thick. Longer length shanks available on request.

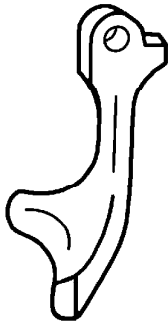

**T & S LEXAN
LEVER ARM (BLUE)
46627**

**T & S GLASS FILLER REPAIR KIT
2032**

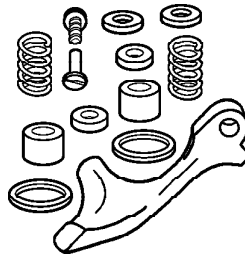

- CONTAINS:**
- 2 SPRINGS
 - 1 HANDLE SCREW
 - 1 HANDLE NUT
 - 2 BRASS WASHERS
 - 2 HEX CAP WASHERS
 - 2 SEAT WASHERS
 - 2 PACKINGS
 - 1 LEXAN LEVER ARM

SINK FAUCETS

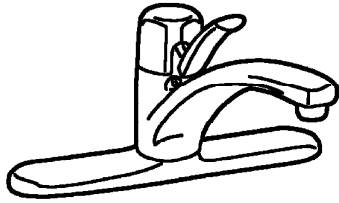

51183

- KITCHEN FAUCET
- 8" COVER PLATE
- 3/8" O.D. COPPER INLET TUBES
- 10" SPOUT
- 2.0 GPM AERATOR @80 PSI

51184

AS ABOVE WITH SPRAY

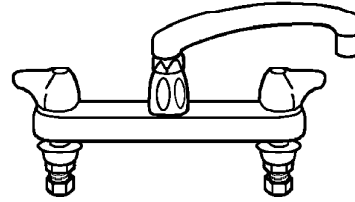

51188

- 8" CENTERS
- 8" SPOUT
- 2.0 GPM AERATOR

2358

- 8" CENTERS
- 8" SPOUT
- 2.0 GPM AERATOR
- LESS SPOUT

51189

AS ABOVE WITH SPRAY

2359

AS ABOVE WITH SPRAY

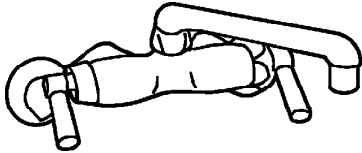

51185

- 4" TO 8-3/8" ADJUSTABLE CENTERS
- 6" SPOUT
- 2.0 GPM AERATOR @80 PSI

50348

- AS ABOVE **LESS SPOUT**
- BUILD WITH SPOUTS BELOW

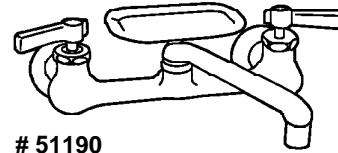

51190

- 7-1/4" TO 8-3/8" ADJUSTABLE CENTERS
- 6" SPOUT
- VALVE MOUNTED SOAP DISH
- 2.0 GPM AERATOR @80 PSI

50349

- AS ABOVE **LESS SPOUT**
- BUILD WITH SPOUTS BELOW

CHICAGO SWING SPOUTS

SEE PAGE G-24 FOR ADDITIONAL SPOUT OPTIONS

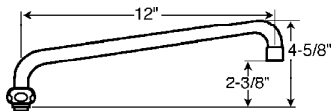

44892

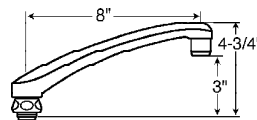

44891

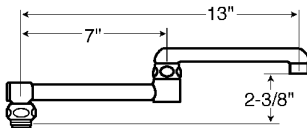

51186

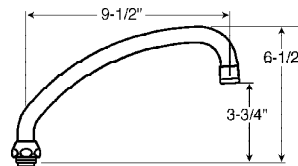

51191

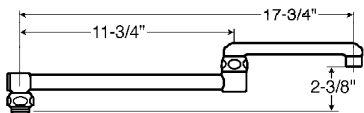

51187

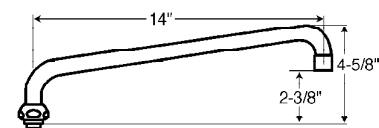

44893

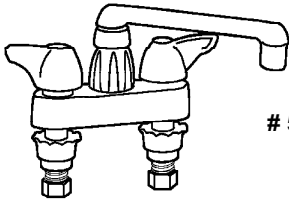

- # 51192**
- 4" CENTERS
 - 6" SPOUT
 - 2.0 GPM AERATOR @80 PSI

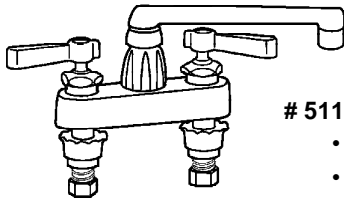

- # 51193**
- 4" CENTERS
 - 6" SPOUT
 - DECK MOUNTED
 - HOSE THREAD SPOUT OUTLET

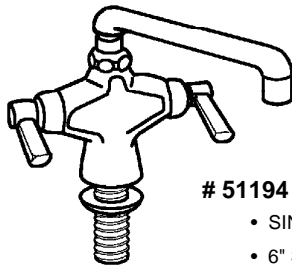

- # 51194**
- SINGLE HOLE MOUNT
 - 6" SPOUT
 - 3/8" COPPER SUPPLY TUBES
 - 2.0 GPM AERATOR @80 PSI

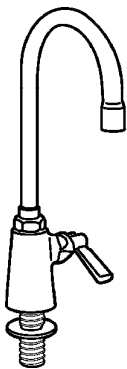

- # 51195**
- SINGLE WATER INLET
 - 5-3/8" SPOUT
 - 2.0 GPM AERATOR @80 PSI

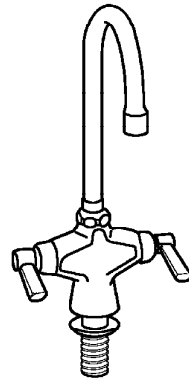

- # 51196**
- SINGLE HOLE MOUNT
 - 5-3/8" SPOUT
 - 3/8" COPPER SUPPLY TUBES
 - 2.0 GPM AERATOR @80 PSI

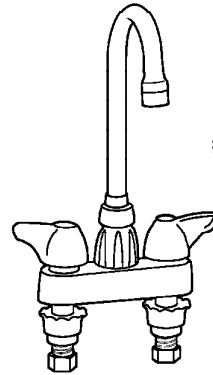

- # 51197**
- 4" CENTERS
 - 3-1/2" SPOUT
 - 2.0 GPM AERATOR @80 PSI

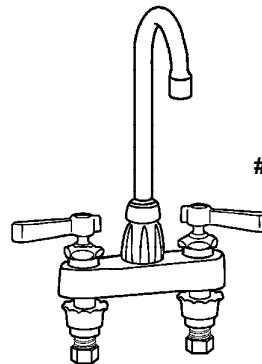

- # 55060**
- 4" CENTERS
 - 3-1/2" SPOUT
 - 2.0 GPM AERATOR @ 80 PSI
 - 1/2" NPS MALE INLETS

REPAIR PARTS

FISHER

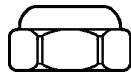

2323
C. P. BONNET



44814
PACKING



50921
FRICTION WASHER

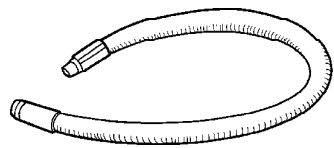

44820
PRE-RINSE HOSE
36" LENGTH
1/4" IPS x 3/8" IPS



2324
SCREW



46635
BLUE INDEX



(UN-INDEXED)

46636
RED INDEX

44816
LEVER HANDLE

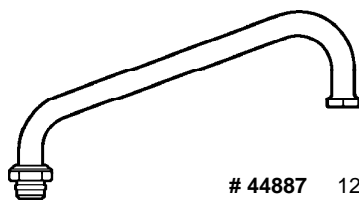

44887 12" SWING SPOUT

2327 14" SPOUT

2328 16" SPOUT

OTHER TYPES AND STYLES AVAILABLE ON REQUEST

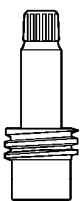

2325
COMPLETE HOT
STEM ASSEMBLY

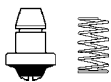

2326
COMPLETE COLD
STEM ASSEMBLY

44819
VALVE STEM REPAIR KIT

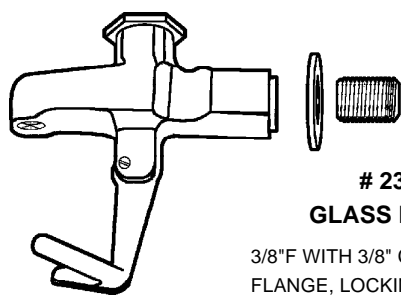

2340
GLASS FILLER

3/8" F WITH 3/8" CLOSE NIPPLE,
FLANGE, LOCKING COMPOUND.



WHITE
PLASTIC
HANDLE



44815 RH
44816 LH (SHOWN)

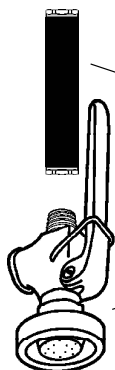

2329
HANDLE FOR #2319

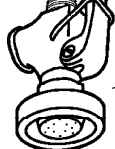

2319
FISHER PRE-RINSE
SPRAY VALVE

LEVER HANDLE WASTE

LEVER WASTE

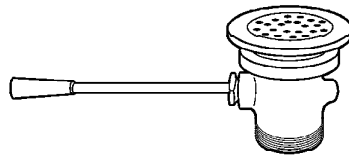

PART #	DRAIN	SINK OPENING
# 2105	1-1/2"	3"
# 2106	1-1/2"	3-1/2"
# 2107	2"	3"
# 2108	2"	3-1/2"

LEVER WASTE WITH 1-1/4" OVERFLOW OUTLET

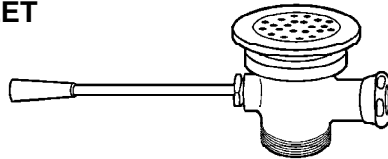

PART #	DRAIN	SINK OPENING
# 2109	1-1/2"	3"
# 2110	1-1/2"	3-1/2"
# 2111	2"	3"
# 2112	2"	3-1/2"

LEVER WASTE WITH OVERFLOW HEAD AND ELBOW

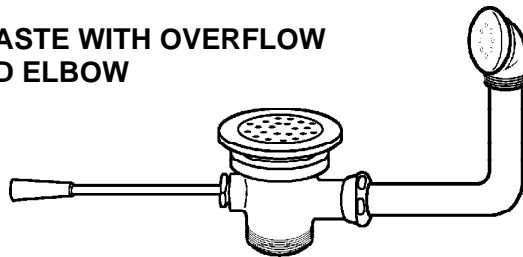

PART #	DRAIN	SINK OPENING
# 2236	1-1/2"	3"
# 2237	1-1/2"	3-1/2"
# 2238	2"	3"
# 2239	2"	3-1/2"

PARTS FOR LEVER HANDLE WASTES

REPAIR KITS

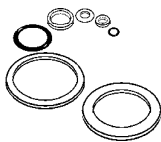

2250
CONTAINS COMMON REPLACEMENT PARTS FOR 3" TWIST WASTES

2360
CONTAINS COMMON REPLACEMENT PARTS FOR 3-1/2" TWIST WASTES

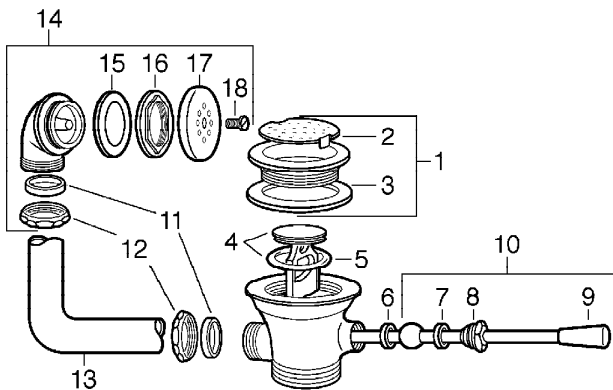

1	# 2227 # 2253	FLANGE ASSEMBLY 4-1/8" OD FLANGE ASSEMBLY 4-3/8" OD
2	# 2119 # 2091	FLAT STRAINER 3-1/8" DIAMETER FLAT STRAINER 3-7/16" DIAMETER
3	# 2122	FLANGE WASHER
4	# 2089	PLUNGER WITH O-RING
5	# 2096	O-RING
6	# 2125	BODY BUSHING
7	# 2126	PACKING NUT BUSHING
8	# 2124	PACKING NUT
9	# 2128	PLASTIC HANDLE KNOB
10	# 2123	LEVER ROD ASSEMBLY
11	# 4903	COUPLING NUT WASHER
12	# 4840	COUPLING NUT
13	# 2100	OVERFLOW ELBOW
14	# 2233	OVERFLOW HEAD ASSEMBLY
15	# 2133	OVERFLOW WASHER
16	# 2100	OVERFLOW FLANGED LOCKNUT
17	# 2135	OVERFLOW STRAINER
18	# 2234	STRAINER MOUNTING SCREW

TWIST HANDLE WASTE

TWIST WASTE

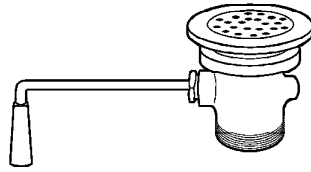

PART #	DRAIN	SINK OPENING
# 2077	1-1/2"	3"
# 2078	1-1/2"	3-1/2"
# 2079	2"	3"
# 2080	2"	3-1/2"

TWIST WASTE WITH 1-1/4" OVERFLOW OUTLET

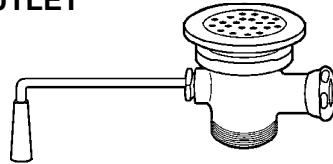

PART #	DRAIN	SINK OPENING
# 2081	1-1/2"	3"
# 2082	1-1/2"	3-1/2"
# 2083	2"	3"
# 2084	2"	3-1/2"

TWIST WASTE WITH OVERFLOW HEAD AND ELBOW

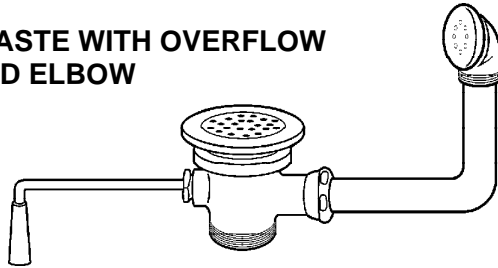

PART #	DRAIN	SINK OPENING
# 2223	1-1/2"	3"
# 2224	1-1/2"	3-1/2"
# 2225	2"	3"
# 2226	2"	3-1/2"

PARTS FOR TWIST HANDLE WASTES

REPAIR KITS

2235
CONTAINS COMMON REPLACEMENT PARTS FOR 3" TWIST WASTES

2360
CONTAINS COMMON REPLACEMENT PARTS FOR 3-1/2" TWIST WASTES

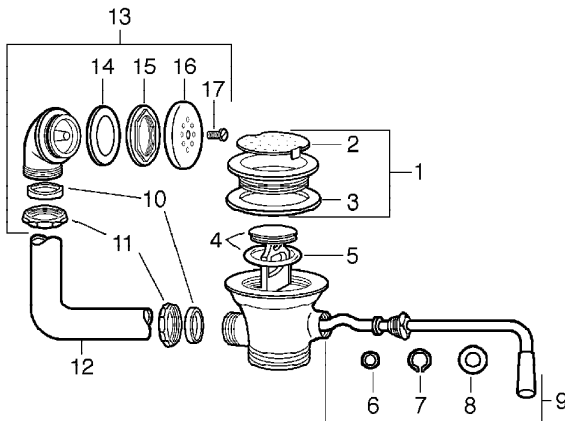

1	# 2227 # 2253	FLANGE ASSEMBLY 4-1/8" O. D. FLANGE ASSEMBLY 4-3/8" O. D.
2	# 2119 # 2091	FLAT STRAINER 3-1/8" DIAMETER FLAT STRAINER 3-7/16" DIAMETER
3	# 2094	FLANGE WASHER
4	# 2089	PLUNGER WITH O-RING
5	# 2096	O-RING
6	# 2229	O-RING
7	# 2230	SNAP RING
8	# 2231	WASHER
9	# 2095	TWIST HANDLE
10	# 4903	COUPLING NUT WASHER
11	# 4840	COUPLING NUT
12	# 2100	OVERFLOW ELBOW
13	# 2233	OVERFLOW HEAD ASSEMBLY
14	# 2102	OVERFLOW WASHER
15	# 2103	OVERFLOW FLANGED LOCKNUT
16	# 2104	OVERFLOW STRAINER
17	# 2234	STRAINER MOUNTING SCREW

LEVER WASTE

OLD STYLE FRANKLIN LEVER WASTE

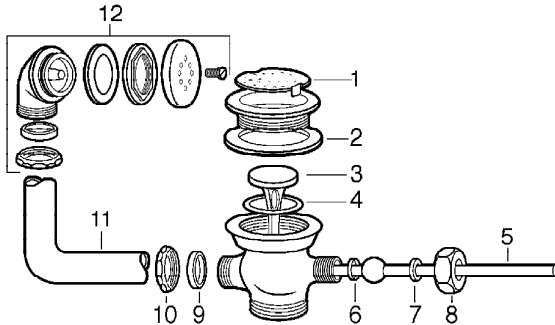

1	# 2144	FLAT STRAINER - 3-1/4"
2	# 44445	FLANGE WASHER
3	# 2142	PLUNGER ONLY
4	# 2096	O-RING
5	# 2148	LEVER ROD WITH BALL
6	# 2151	BODY BUSHING
7	# 2152	PACKING NUT BUSHING
8	# 2150	PACKING NUT
9	# 4903	COUPLING NUT WASHER
10	# 4840	COUPLING NUT
11	# 2100	OVERFLOW ELBOW
12	# 2251	OVERFLOW HEAD ASSEMBLY

2252 REPAIR KIT
CONTAINS COMMON REPLACEMENT
PARTS FOR ALL LEVER AND
TWIST WASTES

LEVER WASTE STRAINER

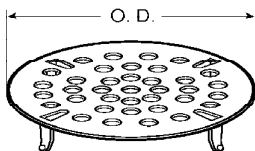

- # 2119 3-1/8" O.D.
- # 2144 3-1/4" O.D.
- # 2091 3-7/16" O.D.

REDUCER # 2256

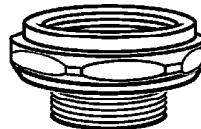

- 2" NPS FEMALE TO 1-1/2" NPS MALE
- NICKEL PLATED BRASS

THE ULTIMATE DRAIN OPENER !



79300

- THRIFT DRAIN CLEANER
CLEARS DRAINS IN MINUTES
- WILL NOT DAMAGE SINKS, TUBS,
BRASS, COPPER, STEEL, CAST IRON,
PLASTIC, OR SEWER CABLES !
- TOTALLY DESTROYS HAIR AND GREASE !
- DOES NOT PRODUCE OFFENSIVE ODORS !

*YOU'VE NEVER SEEN
ANYTHING LIKE
THE POWER OF THRIFT !!*

LEVER WASTE TOOL # 2257

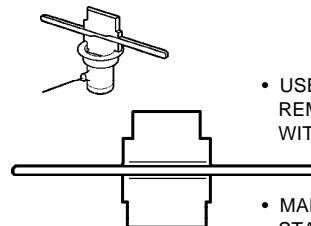

- USE TO INSTALL OR
REMOVE WASTES
WITH 3" OR 3-1/2" OPENINGS
- MADE OF HEAVY DUTY
STAINLESS STEEL

KITCHEN REPAIR

TOP OF THE LINE!

BASKET STRAINER
44129

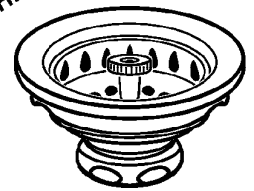

- C. P. FORGED BRASS
- 1-1/2" x 4" TAILPIECE
- 3-1/2" OPENING
- 4-1/2" FLANGE

HEAVY CAST DRAIN ASSEMBLY
FOR BAR SINK - CHROME

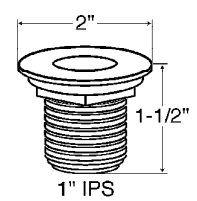

44133
INCLUDES LOCKNUT
AND WASHER

STAINLESS STEEL BASKET STRAINER
44130

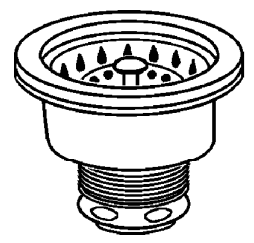

- 3-1/2" OPENING
- 4-1/2" TOP FLANGE

HEAVY CAST DRAIN ASSEMBLY
FOR BAR SINK - CHROME

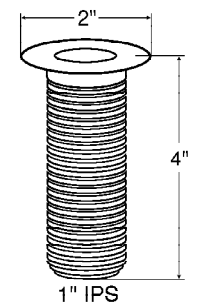

44134
INCLUDES LOCKNUT
AND WASHER

BASKET STRAINER
44131

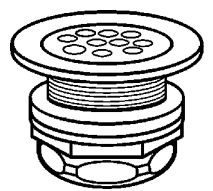

- 2-1/2" OPENING
- 2-7/8" TOP FLANGE

HEAVY CAST DRAIN ASSEMBLY
FOR BAR SINK - CHROME

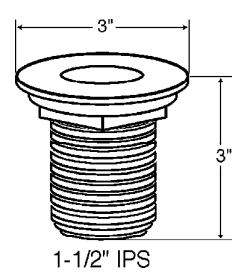

44135
INCLUDES LOCKNUT
AND WASHER

STAINLESS STEEL BASKET STRAINERS

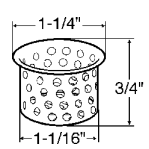

4595

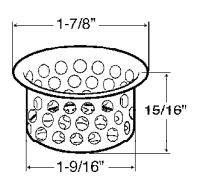

4596

TAILPIECE ASSEMBLIES
(INCLUDES WASHER)

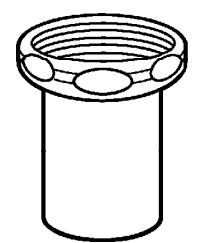

- # 44136
FITS 1" DRAIN
2" LENGTH
- # 44394
FITS 1-1/2" DRAIN
4" LENGTH
- # 2222
FITS 2" DRAIN
4" LENGTH

VAPOR PROOF LIGHTING GLOBE

HEAVY DUTY NATURAL GAS HOSE

CORRUGATED STAINLESS STEEL
3/4" MIP x 3/4" FIP



2211 36"

2366 48"

OTHER SIZES AVAILABLE ON REQUEST

PARTS FOR VAPORPROOF LIGHTING FIXTURES

3-1/4" O.D. x 6-1/2" HIGH

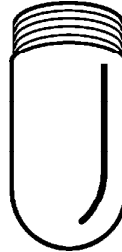

2202
PLASTIC GLOBE

2203
GLASS GLOBE

2204
SHATTERPROOF GLASS GLOBE

2205
HEAT TEMPERED GLASS GLOBE

NATURAL GAS HOSE FOR STATIONARY EQUIPMENT

STAINLESS STEEL CORRUGATED HOSE ENCASED IN STAINLESS STEEL BRAID WITH COATING. 3/4" MIP x 3/4" FIP.

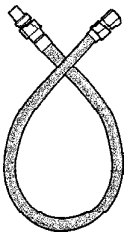

2367 36"

2368 48"

OTHER SIZES AVAILABLE ON REQUEST

WIRE GUARDS

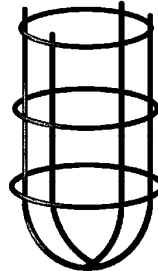

2369
FOR 100 WATT LIGHT FIXTURES

OTHER STYLES AVAILABLE.
CALL FOR ASSISTANCE

QUICK DISCONNECT GAS FITTINGS

- ALLOWS GAS APPLIANCES TO BE DISCONNECTED FROM GAS SUPPLY QUICKLY AND EASILY
- QUICK DISCONNECT AUTOMATICALLY SHUTS OFF GAS SUPPLY

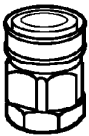

2207 1/2" NPT

2208 3/4" NPT

2209 1" NPT

2210 1-1/4" NPT

OVERFLOW TUBES

2215
RUBBER SEAT. FITS 1" DRAIN
PLASTIC - 7-1/2" LENGTH

2216
RUBBER SEAT. FITS 1" DRAIN
CHROME PLATED - 7-1/2" LENGTH

2217
RUBBER SEAT. FITS 1" DRAIN
CHROME PLATED - 9" LENGTH

2218
TAPERED SEAT. FITS 1" DRAIN
BRASS - 7-1/2" LENGTH

2219
TAPERED SEAT. FITS 1" DRAIN
CHROME PLATED - 7-1/2" LENGTH

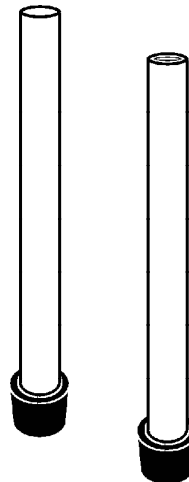

SPECIALTY OVERFLOW TUBES

TWIN SEAL PROVIDE A POSITIVE SEAL.
WHITE PLASTIC TUBE

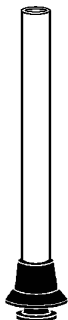

2200
FOR 1" NPS DRAINS
7" HEIGHT

2201
FOR 1-1/2" NPS DRAINS
10" HEIGHT

TUBULAR

"P" TRAP - 17 GAUGE

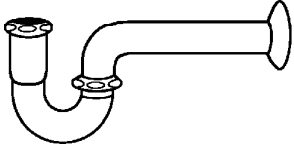

1-1/4"	# 4921
1-1/2"	# 4922
2"	# 44011

FLANGED SINK TAILPIECE - 17 GAUGE

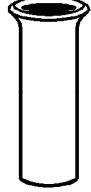

1-1/4" x 8"	# 4820
1-1/4" x 12"	# 44021
1-1/2" x 6"	# 4821
1-1/2" x 8"	# 4822
1-1/2" x 12"	# 4823

"P" TRAP WITH CLEANOUT - 17 GAUGE

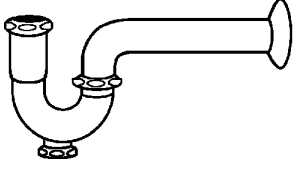

1-1/4"	# 44012
1-1/2"	# 44013
2"	# 44335

2" FLANGED SINK TAILPIECE - 17 GAUGE

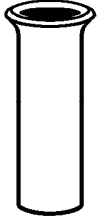

2" x 6"	# 44029
2" x 8"	# 44030
2" x 12"	# 44031

REPAIR TRAPS - 17 GAUGE



1-1/4"	# 4990
1-1/2"	# 4991

- SLIP JOINT CONNECTION
- NO NEED TO DESOLDER TUBE FROM WALL. JUST CUT & SLIP OVER EXISTING TUBE.

DIE CAST SLIP JOINT NUT CHROME PLATED INCLUDES WASHER

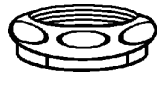

1-1/4"	# 4835
1-1/2" x 1-1/4"	# 4836
1-1/2" x 1-1/2"	# 4838
2"	# 4839
2" x 1-1/2"	# 4837

CAST SLIP JOINT NUT CHROME PLATED INCLUDES WASHER



HEAVY CAST BRASS!

1-1/4"	# 4840
1-1/2" x 1-1/4"	# 4841
1-1/2" x 1-1/2"	# 4842
2"	# 4843
2" x 1-1/2"	# 4844

EXTENSION TUBE SLIP JOINT - 17 GAUGE

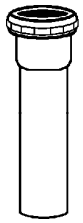

1-1/4" x 6"	# 4936
1-1/4" x 8"	# 4937
1-1/4" x 12"	# 4938
1-1/2" x 6"	# 4939
1-1/2" x 8"	# 4940
1-1/2" x 12"	# 4941

NO-BURST FLEXIBLE STAINLESS STEEL PLUMBING CONNECTORS

3/8" FEMALE COMPRESSION TO 1/2" IPS FEMALE	1/2" IPS FEMALE TO 1/2" IPS FEMALE
12" # 44346	12" # 44352
16" # 44347	16" # 44353
20" # 44348	20" # 44354
1/2" FEMALE COMPRESSION TO 1/2" IPS FEMALE	3/8" MALE COMPRESSION TO 3/8" FEMALE COMPRESSION
12" # 44349	12" # 44527
16" # 44350	20" # 44528
20" # 44351	

EXTENSION TUBES - 17 GAUGE THREADED BOTH ENDS

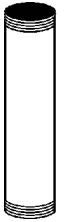

1-1/4" x 4"	# 44024
1-1/4" x 6"	# 44025
1-1/4" x 8"	# 4824
1-1/4" x 12"	# 4825
1-1/2" x 6"	# 44027
1-1/2" x 8"	# 4826
1-1/2" x 12"	# 4827



OTHER SIZES AND STYLES AVAILABLE !!

EDLUND CAN OPENER

MODEL #1

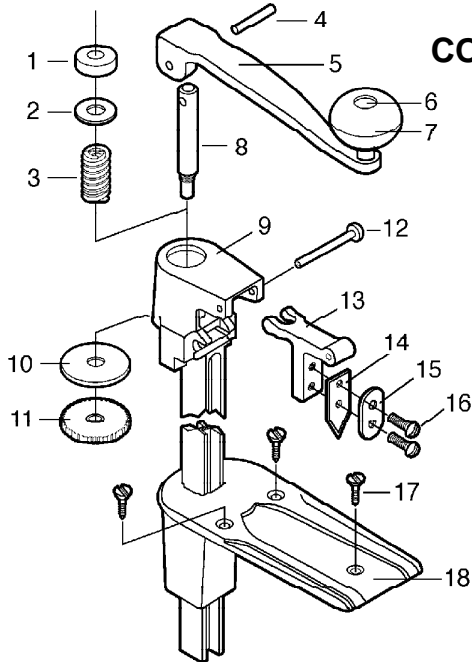

2052 COMPLETE UNIT

1	# 2061	BUSHING
2	# 2370	WASHER
3	# 2062	SPRING
4	# 2371	PIN
5	# 2058	HANDLE
6	# 2372	STUD
7	# 2373	KNOB
8	# 2060	ARBOR
9	# 2059	BAR
10	# 2374	WASHER
11	# 2055	GEAR
12	# 2206	RIVET
13	# 2056	HOLDER
14	# 2054	KNIFE
15	# 2375	SUPPORT
16	# 2063	SCREW
17	# 2207	SCREW
18	# 2057	ASSEMBLY

2208
4, 5, 6, 7, 8
COMPLETE
HANDLE ASSY.

2209
5, 6, 7
HANDLE
SUB ASSY.

2210
13, 14, 15, 16
CUTTER ASSY.

MODEL #2

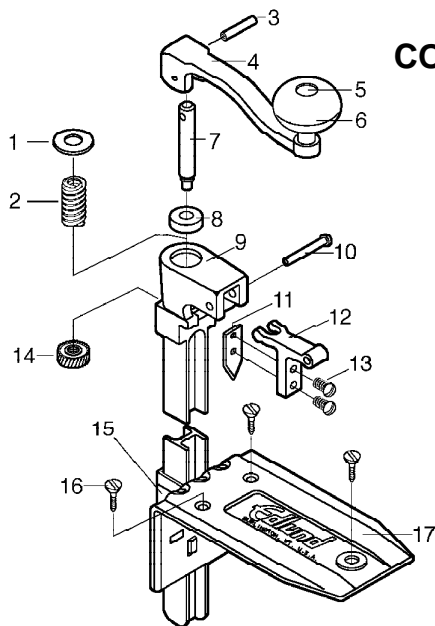

2053 COMPLETE UNIT

1	# 2376	WASHER
2	# 2377	SPRING
3	# 2378	PIN
4	# 2070	HANDLE
5	# 2215	STUD
6	# 2216	KNOB
7	# 2072	ARBOR
8	# 2073	BUSHING
9	# 2071	BAR
10	# 2217	RIVET
11	# 2064	KNIFE
12	# 2066	HOLDER
13	# 2218	SCREW
14	# 2065	GEAR
15	# 2219	LABEL
16	# 2220	SCREW
17	# 2067	ASSEMBLY

2221
3, 4, 5, 6, 7
COMPLETE
HANDLE ASSY.

2222
4, 5, 6
HANDLE SUB
ASSY.

2379
11, 12, 13
CUTTER ASSY.

OTHER MODELS AND PARTS
AVAILABLE ON REQUEST

COFFEE URN

comlinson

SELF CLOSING FAUCET HEAD

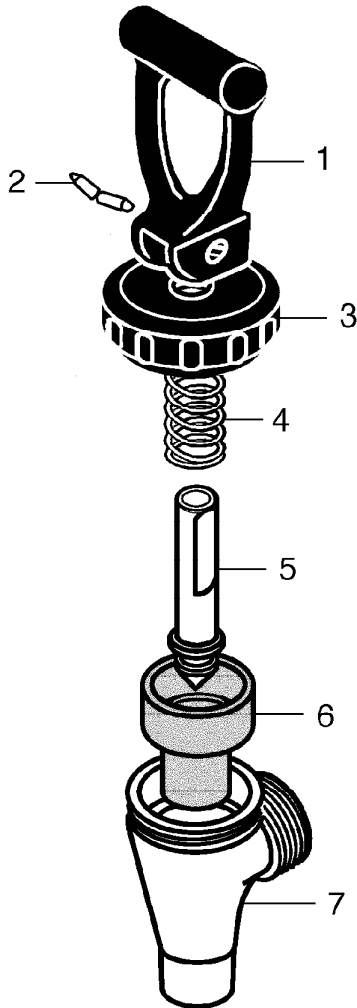

1	HANDLE	# 2043
2	HANDLE PIN (BENT)	# 2044
3	BONNET	# 2045
4	STEM SPRING	# 2046
5	STEM	# 2047
6	SEAT CUP	# 2048
7	BODY	# 2049



UPPER ASSEMBLY WITH
BLACK PLASTIC BONNET

2050



UPPER ASSEMBLY WITH
CHROME PLATED
BRASS BONNET

2051



SELF CLOSING SEPARABLE
FAUCET HEAD

2033

The most widely used urn faucet in the world. Chrome plated brass body with black nylon metal thread bonnet.

SELF CLOSING SEPARABLE
FAUCET HEADS



2040

3/8" NPSM THREAD

For metal or plastic containers. Suitable to dispense water, juices, beverages, as well as certain chemicals and industrial liquids. Complete with two gaskets and aluminum jam nut.

MISCELLANEOUS

STEAM JACKETED KETTLE FAUCET

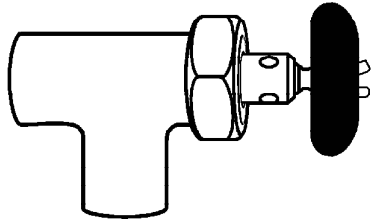

2380
REAMED FOR 1-1/2" O.D. TUBING

2315
REAMED FOR 2" O.D. TUBING

2316
REAMED FOR 3" O.D. TUBING

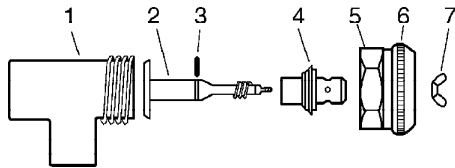

PARTS LIST

- | | |
|------------|-------------|
| 1 BODY | 5 LARGE NUT |
| 2 STEM | 6 HANDLE |
| 3 "O" RING | 7 WING NUT |
| 4 BONNET | |

BRONZE WATER PRESSURE REGULATOR - WATTS -

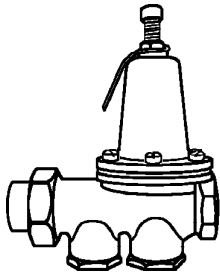

- FOR PRESSURES UP TO 300 LBS.
- ADJUSTABLE FROM 25 TO 75 LBS.
- WITH INTEGRAL STAINLESS STRAINER
- WITH UNION INLET

EQUIPARTS CARRIES A COMPLETE LINE OF REGULATOR AND SAFETY VALVES!

- | | |
|----------------|------|
| # 50141 | 1/2" |
| # 50142 | 3/4" |
| # 50143 | 1" |

3/4" HOT WATER HEATER TEMPERATURE & PRESSURE VALVE

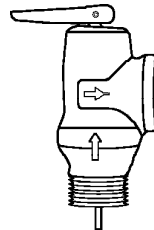

50139 150 PSI (STANDARD)

50140 175 PSI

THERMAL EXPANSION RELIEF VALVE

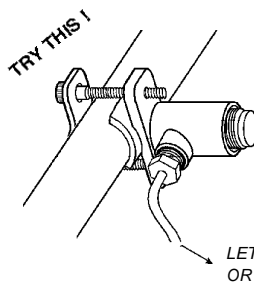

50145

EASY TO INSTALL! CONVENIENT, SELF PIERCING RELIEF VALVE ATTACHES TO 1/2" COPPER SET AT 125 LBS. AN EASY SOLUTION TO THERMAL EXPANSION PROBLEMS.

LET DRAIN INTO LAUNDRY TUB OR FLOOR DRAIN.

FILTERS

UNDER SINK FILTER

2344

INCLUDES MOUNTING BRACKET. ELIMINATES TASTES, ODORS, DIRT, & RUST. SPACE SAVING UNIT FOR CONFINED AREAS PROVIDES CLEAN, CLEAR WATER.



SIZE 3/8" NPT
 HEIGHT 8-13/16"
 MAX DIA 4-7/8"
 FLO RATE 2 GPM
 CAPACITY 2000 GALLONS

POINT OF USE WATER FILTER

2347

ELIMINATES TASTES, ODORS, DIRT, AND RUST. GREAT FOR ICE MACHINES, COFFEE MAKERS, AND GLASS FILLERS.

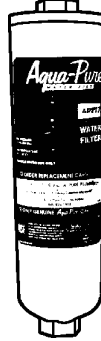

SIZE 1/4" NPT
 HEIGHT 8-3/8"
 MAX DIA 2-1/4"
 FLO RATE .5 GPM
 CAPACITY 1500 GALLONS

POINT OF USE FILTER

2345

INCLUDES MOUNTING BRACKET. TRIPLE ACTION FILTER ELIMINATES TASTES, ODORS, SCALE, DIRT, AND RUST. PROVIDES SPARKLING CLEAR ICE CUBES, FRESH TASTING WATER, COFFEE, & BEVERAGES. REMOVES CHLORINE.



SIZE 1/4" NPT
 HEIGHT 11-1/4"
 MAX DIA 2-1/2"
 FLO RATE .5 GPM
 CAPACITY 1500 GALLONS

POINT OF USE LIME AND SCALE INHIBITOR

44968

GREAT FOR ICE MACHINES, COFFEE MAKERS, STEAMER TRAYS, AND HUMIDIFIERS.



SIZE 1/4" COMPRESSION
 HEIGHT 8"
 MAX DIA 2-1/4"
 FLO RATE .5 GPM

POINT OF USE FILTER

2346

SANITARY QUICK-CHANGE TRIPLE ACTION FILTER ELIMINATES TASTE, ODOR, SCALE, DIRT AND RUST. GREAT FOR DRINKING AND COOKING WATER, ICE CUBES, AND ALL FOOD APPLICATIONS.



SIZE 3/8" NPT
 HEIGHT 11-1/16"
 MAX DIA 3-3/8"
 FLO RATE 2 GPM
 CAPACITY 2000 GALLONS

VENDING MACHINE BACKFLOW PREVENTER

2349

- FOR CARBONATED WATER & CARBON DIOXIDE GAS
- FDA COMPLIANT

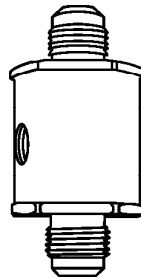

3/8" FLARE CONNECTION # 50162
 1/4" MIPs # 50163
 3/8" MIPs # 50164

VACUUM BREAKERS

BACKFLOW PREVENTER



50146
CHROME PLATED

50147
ROUGH BRASS

3/4" HOSE THREAD INLET AND
OUTLET. USED WITH HOSE
THREAD OUTLET FAUCETS.

ATMOSPHERIC VENT VACUUM BREAKER FOR EXPOSED SERVICE INSTALLATIONS FOR IN-LINE PRESSURE APPLICATIONS

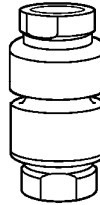

1/4" IPS **# 50165**
3/8" IPS **# 50166**

LABORATORY FAUCET VACUUM BREAKER NOT FOR CONTINUOUS PRESSURE APPLICATIONS

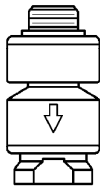

50148

- CHROME FINISH
- 3/8" MIPs x 3/8" FIPs
- FITS STANDARD GOOSENECK
PIPE OUTLETS

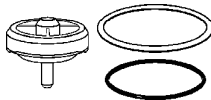

REPAIR KIT
50149

CHICAGO FAUCET VACUUM BREAKER

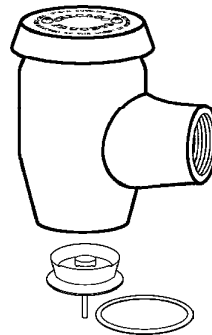

CHROME FINISH

3/8" IPS **# 50167**
1/2" IPS **# 50168**

ROUGH CHROME FINISH

3/8" IPS **# 50169**
1/2" IPS **# 50170**

REPAIR KIT
FOR 3/8" OR 1/2"
50803

ANTI-SIPHON CHROME VACUUM BREAKERS HOT OR COLD WATER SERVICE

WATTS
REGULATOR
CO.

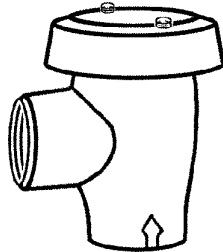

1/4" IPS **# 50150**
3/8" IPS **# 50151**
1/2" IPS **# 50152**
3/4" IPS **# 50314**
1" IPS **# 50153**
1-1/4" IPS **# 50154**
1-1/2" IPS **# 50155**

REPAIR KITS

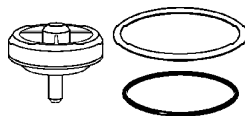

1/4" & 3/8" **# 50156**
1/2" **# 50157**
3/4" **# 50158**
1" & 1-1/4" **# 50159**
1-1/2" **# 50160**
2" **# 50161**

AMERICAN STANDARD VACUUM BREAKER KITS

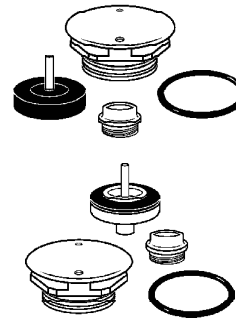

REPAIR KIT
44868

REPAIR KIT
50228

WATERSAVER FAUCET VACUUM BREAKER

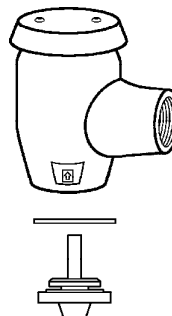

CHROME FINISH

3/8" IPS **# 51192**
1/2" IPS **# 51193**

REPAIR KIT
FOR 3/8" OR 1/2"
51199

SPOUTS

CENTRAL BRASS

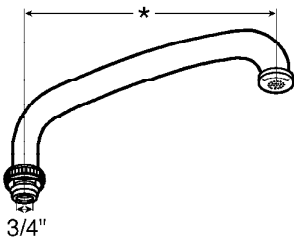

44880 *6"
 # 44879 *8"
 # 51200 *10"
 # 44882 *12"
 # 44877 *14"

3/4"

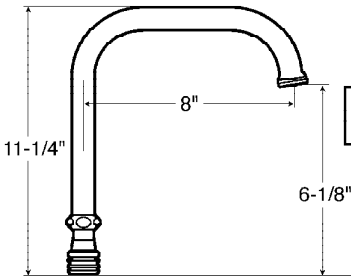

CHICAGO FAUCETS

2352

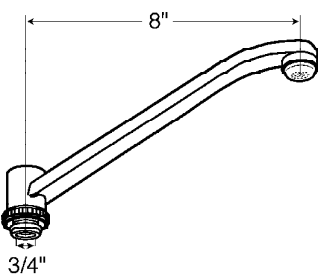

CENTRAL BRASS
 # 44878

3/4"

8"

DELTA

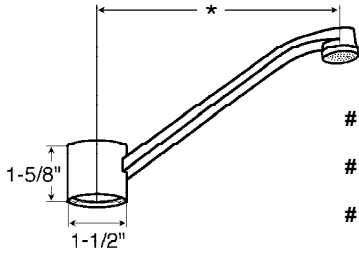

51201 *8"
 # 51202 *10"
 # 51203 *12"

1-5/8"

1-1/2"

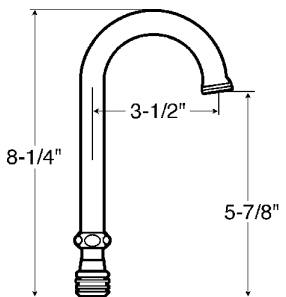

CHICAGO FAUCETS

44888

8-1/4"

3-1/2"

5-7/8"

DELTA-DELEX

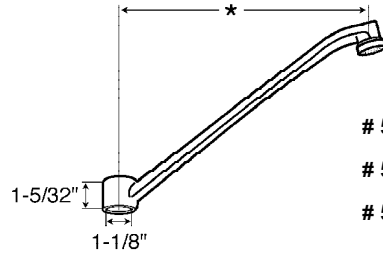

51204 *8"
 # 51205 *10"
 # 51206 *12"

1-5/32"

1-1/8"

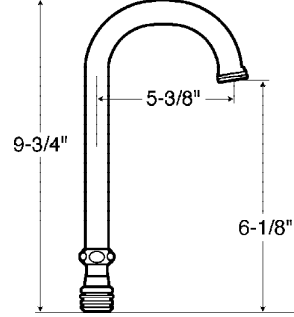

CHICAGO FAUCETS

44889

9-3/4"

5-3/8"

6-1/8"

FISHER

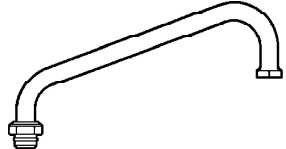

44887 12" SPOUT
 # 2327 14" SPOUT
 # 2328 16" SPOUT

OTHER TYPES AND STYLES AVAILABLE ON REQUEST

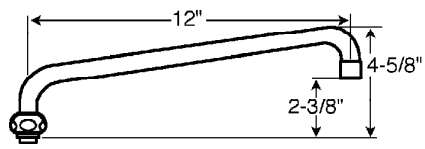

44892

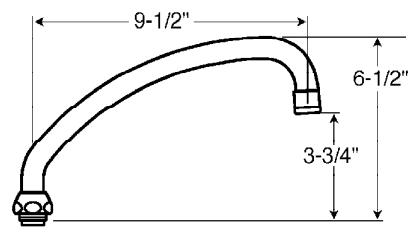

51191

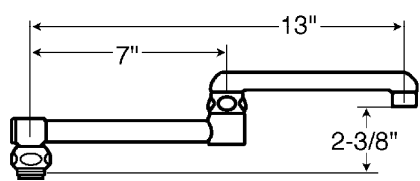

51186

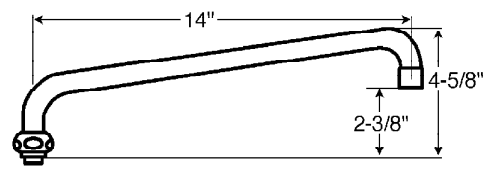

44893

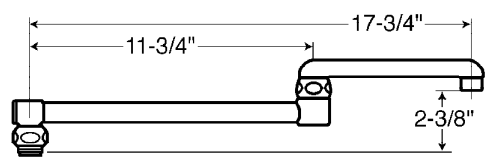

51187

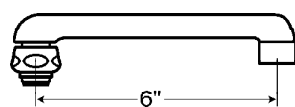

2353

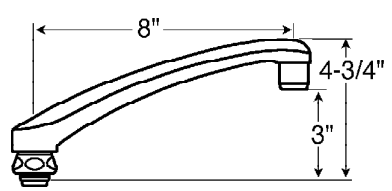

44891

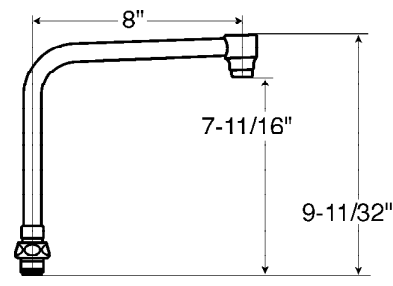

2354

SPOUTS

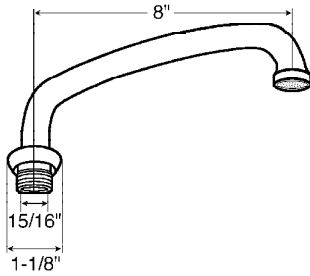

GERBER
51207

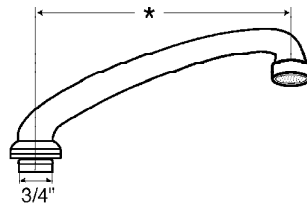

STERLING

- # 51213 *8"
- # 51214 *14"

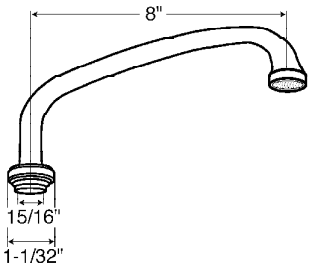

GERBER
51208

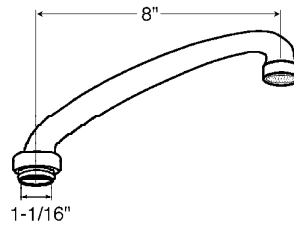

STERLING
51215

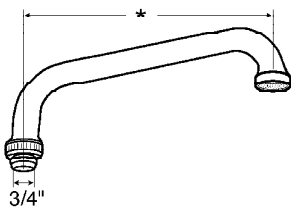

ROYAL BRASS

- # 51209 *8"
- # 51210 *12"
- # 2355 *14"

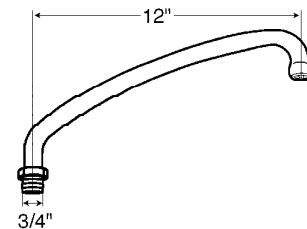

STERLING
51216

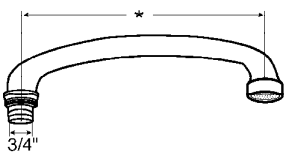

STERLING

- # 51211 *8"
- # 51212 *12"

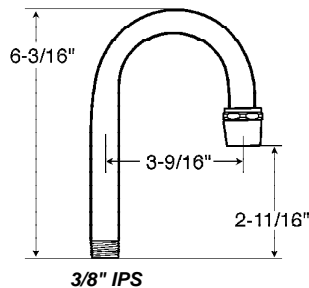

BAR SINK SPOUT
2356

SPOUTS

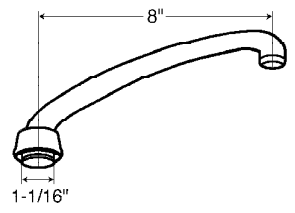

**STERLING
44903**



SWIVEL GOOSENECK

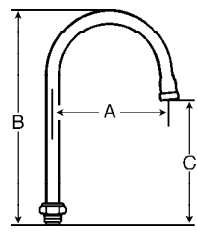

PART#	A	B	C
# 2300	2-3/4"	4-1/2"	2-3/8"
# 2301	2-3/4"	8-3/4"	5-1/8"
# 2302	5-3/4"	8-3/4"	4-3/4"
# 2303	8-3/4"	11-3/4"	5-1/8"

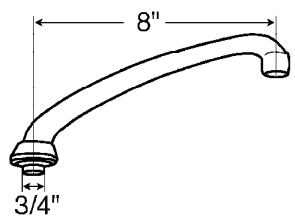

**STERLING
51217**

CUSTOM SPOUT TO YOUR SPECIFICATIONS

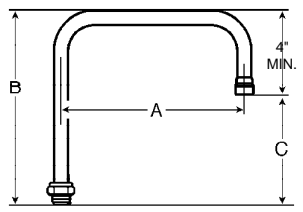

- SPECIFY A, B, C DIMENSIONS
- 3/8" IPS FEMALE OUTLET WITH STREAM REGULATOR REMOVED
- SWIVEL OR 3/8" IPS MALE



DOUBLE JOINTED SWING SPOUTS

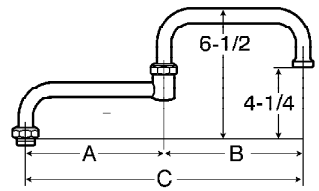

PART#	A	B	C	PART#	A	B	C
# 2291	6"	6"	12"	# 2293	12"	6"	18"
# 2292	9"	6"	15"	# 2294	12"	12"	24"



SWING SPOUTS

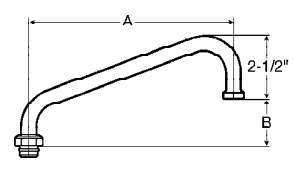

PART#	A	B	PART#	A	B
# 44914	6"	2"	# 2288	14"	4-1/4"
# 2285	8"	2-1/4"	# 44910	16"	5"
# 44915	10"	3"	# 44911	18"	5-3/4"
# 44909	12"	3-3/4"			



RIDGID GOOSENECK

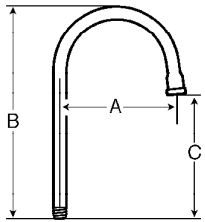

PART#	A	B	C
# 2295	2-3/4"	8"	4-1/2"
# 2296	5-3/4"	9-1/2"	4-1/2"
# 2297	5-3/4"	11-1/2"	6-1/2"
# 2298	5-3/4"	12-1/2"	7-1/2"
# 2299	8-3/4"	10-3/4"	4-1/2"

AVAILABLE WITH VACUUM BREAKER

IF YOU DON'T SEE IT, ASK !

**THOUSANDS
OF PARTS
AVAILABLE !!**

EQUIPARTS



AERATORS CHROME PLATED

REGULAR MALE SLOTLESS # 5002

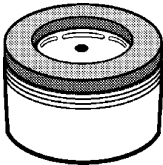

- FOR USE ON REGULAR 15/16" DIAMETER WITH INSIDE THREADS
- 2.0 GPM

SMALL FEMALE # 5018

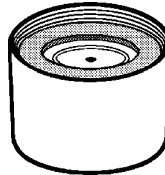

- FOR USE ON SMALL 13/16" DIAMETER WITH OUTSIDE THREADS
- 2.0 GPM

REGULAR FEMALE SLOTLESS # 5005

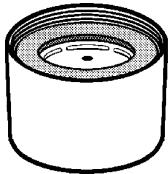

- FOR USE ON REGULAR 15/16" DIAMETER WITH OUTSIDE THREADS
- 2.0 GPM

SMALL MALE SLOTLESS # 5013

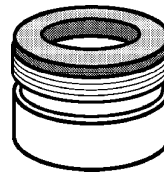

- FOR USE ON SMALL 13/16" DIAMETER WITH INSIDE THREADS
- 2.0 GPM

DUAL THREAD SLOTTED # 5007

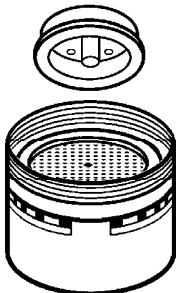

- FOR USE ON REGULAR 15/16" DIAMETER WITH INSIDE OR OUTSIDE THREADS
- WITH REMOVABLE 2.0 GPM INSERT

DUAL THREAD SLOTLESS # 5404

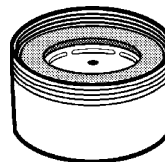

- FOR USE ON REGULAR 15/16" DIAMETER WITH INSIDE OR OUTSIDE THREAD
- 2.0 GPM

**SOFT FLO AERATOR
50010**

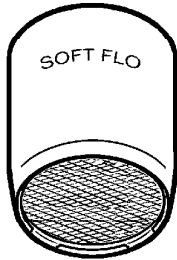

FITS ONLY CHICAGO FAUCET
13/16" - 24 THREAD

**MALE VANDAL PROOF
5001**

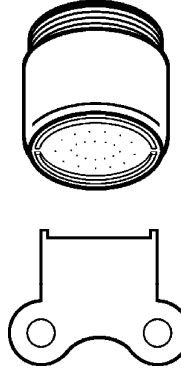

WITH SPECIAL ROTATING
OUTER SLEEVE. FOR USE ON
REGULAR FAUCET (15/16")
WITH INSIDE THREADS.
2.0 GALLONS PER MINUTE.

**DIVERTER WITH FEMALE AERATOR
50011**

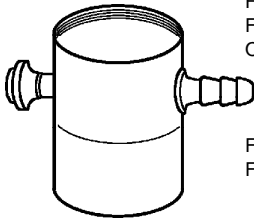

FOR USE ON REGULAR
FAUCET (15/16" DIA) WITH
OUTSIDE THREADS.

FOR REMOTE WATER
FILTERS AND ACCESSORIES.

**FEMALE VANDAL PROOF
50013**

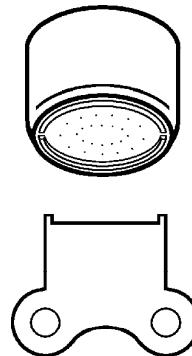

WITH SPECIAL ROTATING
OUTER SLEEVE. FOR USE
ON REGULAR FAUCET (15/16")
WITH OUTSIDE THREADS.
2.0 GALLONS PER MINUTE.

**SANITARY LAMINAR FLOW
50012**

TRY THIS!



- 15/16" DIA - DUAL THREADS
- 2.5 GPM
- HOSPITAL APPROVED

EXCLUDES AIR FROM
WATER STREAM. FOR USE
IN DEMANDING SANITARY
CONDITIONS. LAMINAR FLOW
IS COMPLETELY SILENT AND
WILL NOT SPLASH.

**SMALL MALE VANDAL PROOF
5014**

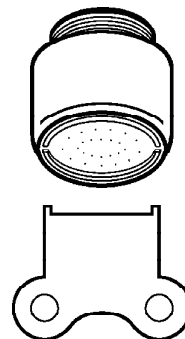

WITH SPECIAL ROTATING
OUTER SLEEVE. FOR USE ON
SMALL FAUCET (13/16")
WITH INSIDE THREADS.
2.0 GALLONS PER MINUTE.

AERATORS SPECIALTY

FLO GUARD ANTI SCALD # 50014

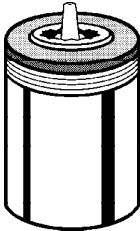

15/16" DUAL THREAD AERATOR
AUTOMATICALLY REDUCES FLOW
TO A TRICKLE WHEN TEMPERATURE
OF WATER BECOMES POTENTIALLY
SCALDING. GREAT FOR NURSING
HOMES, ELEMENTARY SCHOOLS,
HANDICAPPED.

SWIVEL AERATOR # 50266



15/16 DUAL THREAD
2.5 GALLONS PER MINUTE

ULTRA LOW FLO



50016

15/16" DUAL THREAD
.5 GALLONS PER MINUTE

50070

15/16" DUAL THREAD
1.5 GALLON PER MINUTE

GREAT FOR PUBLIC WASHROOMS !

TAP SAVER DELUXE # 50017



USE ON/OFF CONTROL
TO SAVE UP TO 60%
IN ENERGY AND WATER !
15/16" DUAL THREAD

FAUCET MOUNTED EYE WASHER # 50015

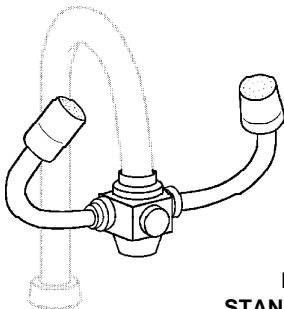

CONVERT ANY GOOSE-
NECK FAUCET INTO AN
EMERGENCY EYE WASH
STATION WITH A PULL
OF A KNOB.

**EYE WASHER FOR
STANDARD SPOUT FAUCETS
50267**

SWING-N-SPRAY # 50018

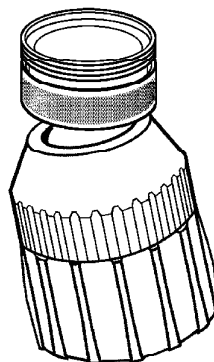

15/16" DUAL THREAD TURNS
FOR AERATOR OR SPRAY.
CHROME SWIVEL WITH
WHITE BODY.

STRAINERS

STAINLESS STEEL SNAP-IN DRAIN COVER

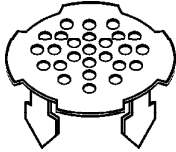

- 2" PIPE SIZE # 44187
- 3" PIPE SIZE # 44188
- 4" PIPE SIZE # 44189

CAST IRON

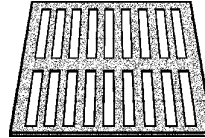

PART #	SIZE	THICKNESS
# 44255	6" x 6"	3/8"
# 44256	8" x 8"	1/2"
# 44257	10" x 10"	1/2"
# 44258	12" x 12"	1/2"
# 44259	14 x 14"	1"

EXPANSION PLUGS

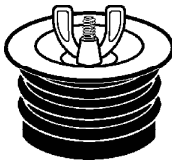

- 1-1/2" # 44309
- 2" # 44310
- 3" # 44311
- 4" # 44312
- 5" # 44313
- 6" # 44314

CAST IRON

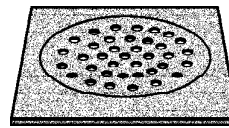

PART #	SIZE
# 44260	6" x 6"
# 44261	8 x 8"
# 44262	10" x 10"
# 44263	12" x 12"

DRAIN OPENER - HOSE CONNECTION



JUST INSERT INTO DRAIN LINE OPENING. AUTOMATICALLY EXPANDS AND FORMS A SEAL WHEN FAUCET IS TURNED ON. PULSATING WATER LOOSENS AND CLEARS BLOCKAGE.

- 1" TO 2" PIPE SIZE # 44315
- 1-1/2" TO 3" PIPE SIZE # 44316
- 3" TO 4" PIPE SIZE # 44317

CAST IRON



PART #	DIAMETER	THICKNESS
# 44264	2-3/4"	3/16"
# 44265	3-3/4"	3/16"
# 44266	4-7/8"	3/8"
# 44267	5-7/16"	3/16"
# 44268	6-7/8"	3/8"
# 44269	7-3/8"	3/8"
# 44270	8-3/8"	1/2"

FLOOD GUARDS

PREVENTS BASEMENT FLOODING

OPERATES LIKE A CHECK VALVE TO SEAL OFF WATER BACK-UP CAUSED BY OVERLOADED SEWERS. WHEN SEWER BEGINS TO BACK UP, FLOAT RISES TO SEAL OFF DRAIN OPENING.



INSTALLS IN MINUTES !

- 2" FLOAT MODEL # 44436
- 3" FLOAT MODEL # 44437
- 4" FLOAT MODEL # 44438

CAST IRON

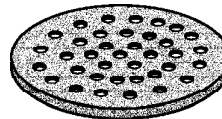

OTHER SIZES AVAILABLE ON REQUEST.

CALL WITH DIAMETER, THICKNESS, & MATERIAL !

PART #	DIAMETER	THICKNESS
# 44271	3"	3/8"
# 44272	4"	3/8"
# 44273	4-5/16"	3/16"
# 44274	4-13/16"	3/16"
# 44275	5"	3/8"
# 44276	5-11/16"	3/16"
# 44277	6"	15/32"
# 44278	6-5/16"	3/16"
# 44279	6-5/8"	3/16"
# 44280	6-13/16"	3/16"
# 44281	6-7/16"	1/4"
# 44282	7"	9/16"
# 44283	8"	5/8"
# 44284	9-1/4"	1/4"
# 44285	9-7/8"	3/16"
# 44286	10"	23/32"
# 44287	11-1/4"	1/4"

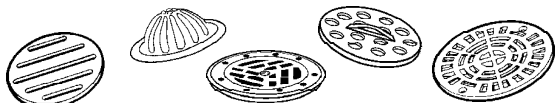

MANY OTHER TYPES AND STYLES AVAILABLE. CALL FOR ASSISTANCE !



GLIDES

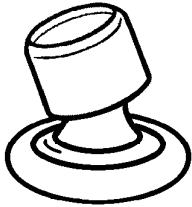

ALL STEEL SWIVEL GLIDE
(OUTSIDE GRIP)

9000
FITS 5/8" O.D. TUBING
OUR MOST POPULAR GLIDE !
(OLD PART# 9000-S)

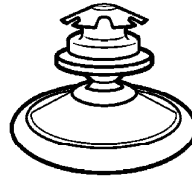

ALL STEEL SWIVEL GLIDE
FITS AMERICAN SEATING

9006
FITS 11/16" OD, 9/16" ID
1-3/16" PLATED STEEL BASE

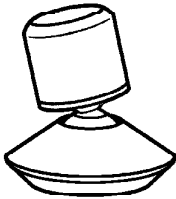

ALL STEEL SWIVEL GLIDE

9003
FITS 9/16" OD, 7/16" ID
1-1/4" PLATED STEEL BASE

NYLON BASE AVAILABLE ON REQUEST

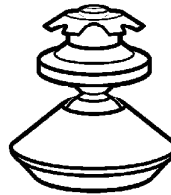

ALL STEEL SWIVEL GLIDE

FITS 9/16" OD, 7/16" ID **# 9002***
FITS 5/8" OD, 1/2" ID **# 9187***
FITS 3/4" OD, 5/8" ID **# 9082**
FITS 7/8" OD, 3/4" ID **# 9001**

* NYLON BASE AVAILABLE ON REQUEST



ALL STEEL SWIVEL GLIDE

9005
FITS 3/4" OD, 5/8" ID
1-3/16" PLATED STEEL BASE

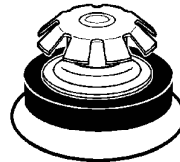

NON SWIVEL GLIDE

9008
FITS 3/4" OD, 5/8" ID
1-1/16" PLATED STEEL BASE

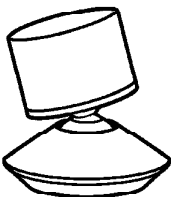

ALL STEEL SWIVEL GLIDE

9025
FITS 3/4" OD, 5/8" ID
1-1/4" PLATED STEEL BASE

NYLON BASE AVAILABLE ON REQUEST

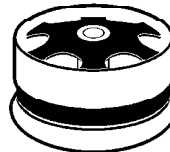

NON SWIVEL GLIDE

9007
FITS 1" OD, 7/8" ID
1-1/16" PLATED STEEL BASE

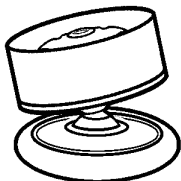

ALL STEEL SWIVEL GLIDE

9004
FITS 1" OD, 7/8" ID

NYLON BASE AVAILABLE ON REQUEST

GLIDE REMOVING TOOL

9053

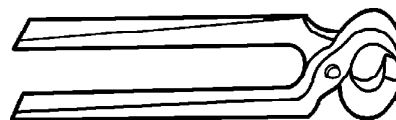

GLIDES & TIPS

SMOOTH RUBBER CRUTCH TIP - BLACK

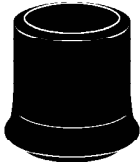

- # 9034 FITS 3/4" O.D.
- # 9035 FITS 7/8" O.D.
- # 9036 FITS 1" O.D.
- # 9037 FITS 1-1/4" O.D.

WHITE AVAILABLE ON REQUEST

HEAVY DUTY INSTITUTIONAL TAN POLY TIP



- 3/4" # 9144
- 7/8" # 9028
- 1" # 9029
- 1-1/8" # 9054

OUR MOST POPULAR TIP!

RIBBED RUBBER CRUTCH TIP - BLACK

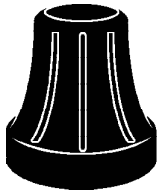

- # 9199 FITS 3/4" O.D.
- # 9200 FITS 7/8" O.D.
- # 9201 FITS 1" O.D.
- # 9203 FITS 1-1/4" O.D.

PLASTIC CAPS - WHITE

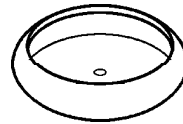

RESTORE WORN OUT CHAIR GLIDES AND ADD YEARS OF USE BY ADDING OUR PLASTIC CAPS OVER EXISTING BASE!

MANY SIZES AVAILABLE.
SEND YOUR SAMPLE FOR PROPER FIT!

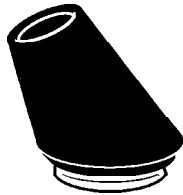

- # 9014
BRUNSWICK RUBBER BOOT
FITS REAR CHAIR FOOT

BLACK SQUARE ROCKER INSERT GLIDE

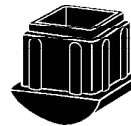

- # 9159 FITS 3/4" O.D. SQ. TUBE
- # 9160 FITS 13/16" O.D. SQ. TUBE

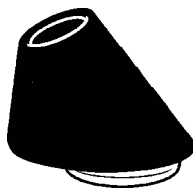

- # 9015
BRUNSWICK RUBBER BOOT
FITS FRONT CHAIR FOOT

CLEAR SQUARE ROCKER INSERT GLIDE

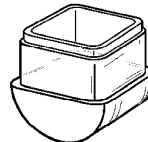

- # 9183
FITS 7/8" O.D. SQ. TUBE

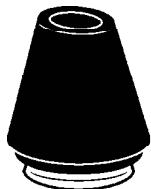

- # 9013
BRUNSWICK RUBBER BOOT
FITS TABLE FOOT

ECONOMY ROUND CAPS

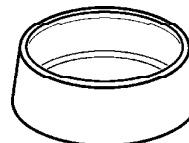

- # 9174 FITS 7/8" OD TUBE
- # 9175 FITS 1" OD TUBE
- # 9176 FITS 1-1/8" OD TUBE
- # 9177 FITS 1-1/4" OD TUBE

GLIDES, TIPS, & INSERTS



TRY THIS !

Use threaded spring clip inserts with machine screw glides to level tubular furniture on uneven floors.

SEE PAGES N-4 & N-5 FOR LEVELERS

THREADED SPRING CLIP INSERT

1/4 -20

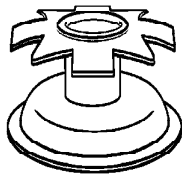

OD TUBE SIZE	PART #
3/4"	# 9107
13/16"	# 9108
7/8"	# 9109
1"	# 9110
1-1/8"	# 9111
1-1/4"	# 9112

LARGER SIZES AVAILABLE UPON REQUEST

5/16-18

OD TUBE SIZE	PART #
7/8"	# 9113
1"	# 9114
1-1/8"	# 9115
1-1/4"	# 9116
1-1/2"	# 9117

3/8-16

OD TUBE SIZE	PART #
7/8"	# 9118
1"	# 9119
1-1/8"	# 9120
1-1/4"	# 9121
1-1/2"	# 9122

THREADED SPRING CLIP INSERT

1/4-20

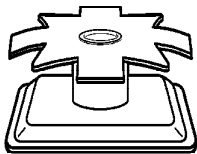

OD TUBE SIZE	PART #
3/4"	# 9123
13/16"	# 9124
7/8"	# 9125
1"	# 9126
1-1/8"	# 9127
1-1/4"	# 9128

LARGER SIZES AVAILABLE UPON REQUEST

5/16-18

OD TUBE SIZE	PART #
7/8"	# 9129
1"	# 9130
1-1/8"	# 9131
1-1/4"	# 9132
1-1/2"	# 9132
2"	# 9133

3/8-16

OD TUBE SIZE	PART #
7/8"	# 9134
1"	# 9135
1-1/8"	# 9136
1-1/4"	# 9137
1-1/2"	# 9138
2"	# 9139

TWO SIDED METAL THREADED INSERT

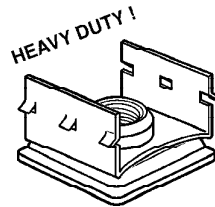

1/4-20 THREAD

FITS 3/4" OD TUBE	# 9140
FITS 7/8" OD TUBE	# 9141

5/16-18 THREAD

FITS 3/4" OD TUBE	# 9142
FITS 7/8" OD TUBE	# 9143

SQUARE TUBING SWIVEL GLIDE



FITS 3/4" OD, 5/8" ID	# 9050
FITS 7/8" OD, 3/4" ID	# 9009
FITS 1" OD, 7/8" ID	# 9010
FITS 1-1/8" OD, 1" ID	# 9106

1-1/16" PLATED STEEL BASE

SQUARE TUBING SWIVEL GLIDE

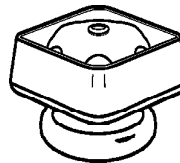

9023

FITS 7/8" OD, 3/4" ID
15/16" PLATED STEEL BASE
GOLD NYLON SLEEVE

DUAL LEG "SIAMESE" CAP

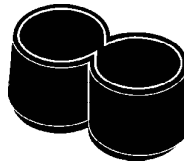

FITS 3/8" OD TUBES	# 9145
FITS 1/2" OD TUBES	# 9146
FITS 5/8" OD TUBES	# 9147
FITS 3/4" OD TUBES	# 9148
FITS 1" OD TUBES	# 9149

NON-MARKING PLASTIC BALL CAP

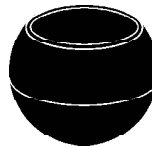

FITS 3/8" OD TUBE	# 9150
FITS 1/2" OD TUBE	# 9151
FITS 5/8" OD TUBE	# 9152
FITS 3/4" OD TUBE	# 9153
FITS 1" OD TUBE	# 9154

WORKS GREAT ON SLIGHTLY ANGLED LEGS

LEVELERS

MACHINE SCREW GLIDE

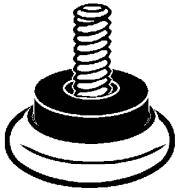

9077

1/4-20 x 1/2" STEM
7/8 PLATED STEEL BASE

9078

1/4-20 x 1/2" STEM
1-11/16" PLATED STEEL BASE

MACHINE SCREW GLIDE

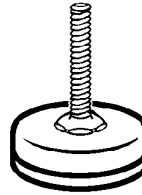

9087 1/4-20 x 1" STEM

9088 5/16-18 x 1" STEM

9089 5/16-18 x 1-1/2" STEM

9090 3/8-16 x 1" STEM

9091 3/8-16 x 1-1/2" STEM

1-3/8" NYLON BASE WITH
PLATED STEEL SHELL

MACHINE SCREW GLIDE

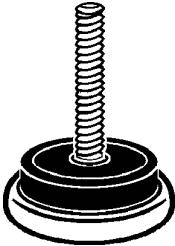

9019

1/4-20 X 1" STEM
1-1/16" PLATED STEEL BASE

9079

5/16-18 X 1" STEM
1-1/16 PLATED STEEL BASE

9080

3/8-16 X 1" STEM
1-1/16" PLATED STEEL BASE

NON-SKID MACHINE SCREW GLIDE

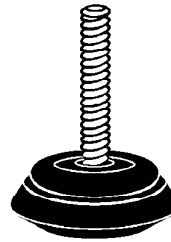

9092

1/4-20 x 1" STEM
1-1/8 RUBBER BASE

9093

5/16-18 x 1" STEM
1-1/8" RUBBER BASE

9094

3/8-16 x 1" STEM
1-1/8 RUBBER BASE

MACHINE SCREW GLIDE

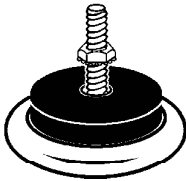

9020

8/32 X 1/2" STEM
1-1/16" PLATED STEEL BASE
INCLUDES NUT

9081

1/4-20 X 1/2" STEM
1-1/16" PLATED STEEL BASE
(NUT NOT INCLUDED)

WOODSERTS

NEED TO ASSEMBLE SOMETHING SEMI-PERMANENTLY ?
NEED TO TAKE IT APART AND PUT IT BACK TOGETHER
FREQUENTLY ? THE ANSWER IS OUR SOLID BRASS OR
STEEL THREADED INSERTS. DRILL A HOLE IN THE WOOD
THE SAME DIAMETER AS THE BODY OF THE INSERT, AND
SIMPLY THREAD THE INSERT INTO THE HOLE USING A
SCREW DRIVER !

PART #	SIZE	LENGTH	DRILL SIZE
--------	------	--------	------------

# 29000	8-32	3/8"	1/4"
---------	------	------	------

# 29001	10-24	1/2"	3/8"
---------	-------	------	------

# 29002	1/4"-20	1/2"	3/8"
---------	---------	------	------

# 29003	5/16"-18	5/8"	1/2"
---------	----------	------	------

# 29004	3/8"-16	5/8"	1/2"
---------	---------	------	------

SOLID BRASS



PART #	SIZE	LENGTH	DRILL SIZE
--------	------	--------	------------

# 29005	8-32	3/8"	1/4"
---------	------	------	------

# 29006	10-24	1/2"	3/8"
---------	-------	------	------

# 29007	1/4-20	1/2"	3/8"
---------	--------	------	------

# 29008	5/16-18	5/8"	1/2"
---------	---------	------	------

# 29009	3/8-16	5/8"	1/2"
---------	--------	------	------

STEEL ZINC PLATED

ECONOMY MACHINE SCREW GLIDE

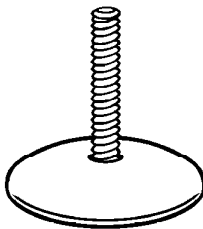

9095 1/4-20 x 1" STEM

9096 1/4-20 x 1-1/2" STEM

9097 5/16-18 x 1-1/2" STEM

9098 3/8-16 x 1-1/2" STEM

1-1/2" NYLON BASE

MACHINE SCREW GLIDE

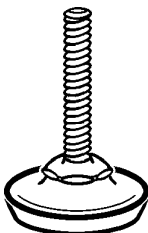

9082 1/4-20 x 1" STEM

9083 5/16-18 x 1" STEM

9084 5/16-18 x 1-1/2" STEM

9085 3/8-16 x 1" STEM

9086 3/8-16 x 1-1/2" STEM

1-1/8" NYLON BASE WITH
PLATED STEEL SHELL

TEE NUTS FOR WOOD FURNITURE

DRILL HOLE IN WOOD SAME DIAMETER AS
BODY OF NUT AND HAMMER IN PLACE !

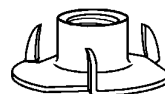

29010 1/4"

29011 5/16"

29012 3/8"

LEVELERS

TOP OF
THE LINE !

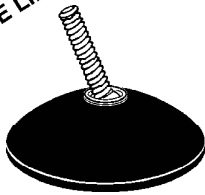

MACHINE SCREW SWIVEL GLIDE

9060

5/16-18 x 1-1/8
2-1/8" BROWN BAKELITE BASE
GREAT FOR CARPET,
HARDWOOD, OR TILE !

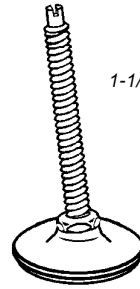

MACHINE SCREW SWIVEL GLIDE

1-1/2" NYLON BASE WITH PLATED STEEL SHELL

- # 9065 3/8-16 x 1-1/2" STEM
- # 9066 3/8-16 x 2-1/2" STEM
- # 9067 3/8-16 x 3" STEM
- # 9068 3/8-16 x 3-1/2" STEM
- # 9069 3/8-16 x 4" STEM

MACHINE SCREW SWIVEL GLIDE

TOP OF
THE LINE !

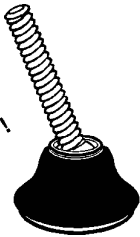

9061

5/16-18 x 1-1/8"
1-3/16" BROWN BAKELITE BASE
GREAT FOR CARPET,
HARDWOOD, OR TILE !

SELF LEVELING SCREW GLIDE

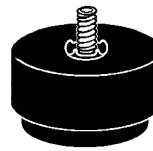

9070

1/4-20 x 1/2" STEM
SPRING LOADED SELF LEVELING
PLASTIC GLIDES

MACHINE SCREW SWIVEL GLIDE

TOP OF
THE LINE !

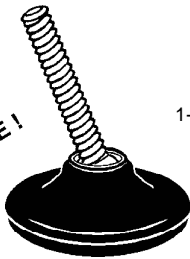

9062

5/16-18 x 1-1/8"
1-5/8" BROWN BAKELITE BASE
GREAT FOR CARPET,
HARDWOOD, OR TILE

PNEUMATIC SELF LEVELING STEEL GLIDE

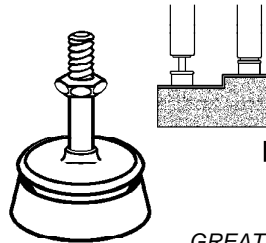

9071

1/4-20 X 1/2" STEM
WITH GREY PLASTIC
SNAP-ON BASE COVER

AUTOMATICALLY EXPANDS
AND CONTRACTS !

GREAT FOR RESTAURANTS !

MACHINE SCREW SWIVEL GLIDE

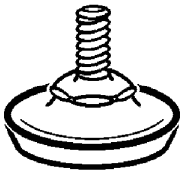

9063

1/4-20 x 1/2" STEM
1-1/8" NYLON BASE WITH
PLATED STEEL SHELL

MACHINE SCREW SWIVEL GLIDE

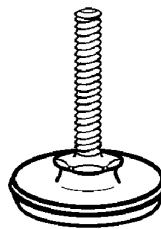

- # 9072 1/4-20 x 1" STEM
- # 9073 5/16-18 x 1" STEM
- # 9074 5/16-18 x 1-1/2" STEM
- # 9075 3/8-16 x 1" STEM
- # 9076 3/8-16 x 1-1/2" STEM

1-1/8" NYLON BASE WITH
PLATED STEEL SHELL

MACHINE SCREW SWIVEL GLIDE

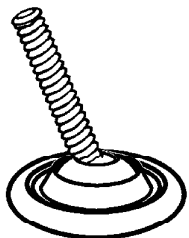

9064

1/4-20 x 1" STEM
1-3/16" PLATED STEEL BASE

MACHINE SCREW SWIVEL GLIDE

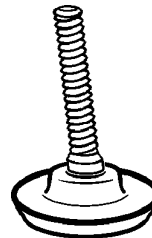

9021

1/4-20 X 1-1/8" STEM
NYLON BASE

BUMPERS & GLIDES

NAIL GLIDE



9012
7/8" CHROME BASE

9052
1-1/16" PLATED STEEL BASE

9099
1-1/4" PLATED STEEL

MACHINE SCREW BUMPER



9197
8/32 x 1/4 SCREW
23/32 DIA x 3/8 HIGH

DECORATIVE SWIVEL NAIL GLIDE



TOP OF THE LINE!

- BROWN BAKELITE BASE
- EXTRA HEAVY NAIL
- GREAT FOR CARPET, HARDWOOD, AND TILE

1-3/16" BASE **# 9100**

1-5/8" BASE **# 9101**

WHITE RECESSED BUMPERS

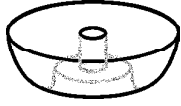

9198
3/32 DIA x 11/32 HIGH
INCLUDES MOUNTING SCREW

ECONOMY PLASTIC NAIL GLIDES

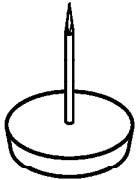

5/8" WHITE BASE **# 9102**

5/8" BEIGE BASE **# 9103**

7/8" WHITE BASE **# 9104**

7/8" BEIGE BASE **# 9105**

RECESSED RUBBER BUMPER WITH REINFORCING WASHER



9184
3/4OD X 9/16 HIGH

GREAT FOR PEWS OR KNEELERS!

NAIL GLIDE - NON-MARKING PLASTIC

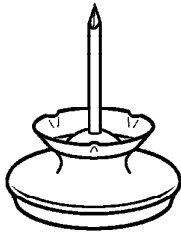

7/8" BASE **# 9189**

1-1/8" BASE **# 9190**

1-5/16" BASE **# 9191**

1-11/16" BASE **# 9192**

KNEELER SHOE



9185
BROWN RUBBER
2-1/2"L x 1-1/8"W x 1/2"H

OTHER PEW AND KNEELER PARTS AVAILABLE

THREE PRONG METAL GLIDE



1/2" BASE **# 9193**

5/8" BASE **# 9194**

7/8" BASE **# 9195**

1-1/8" BASE **# 9196**

STEM BUMPERS

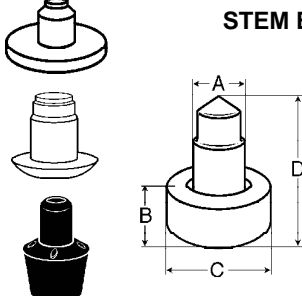

SEND US YOUR REQUIREMENTS!

A _____

B _____

C _____

D _____

GLIDES & CAPS

CLEAR SLED GLIDE

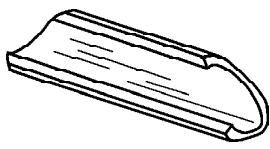

9166
FITS 7/16" OD TUBE

ROUND CHROME SPRING CAP

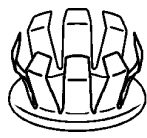

9047 FITS 3/4" OD TUBE
9048 FITS 7/8" OD TUBE
9049 FITS 1" OD TUBE

CLEAR SLED GLIDE

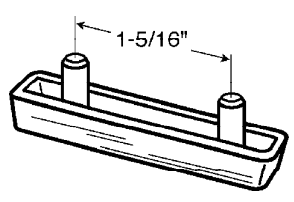

9167

SNAP-ON FLOOR PROTECTORS FOR WROUGHT IRON

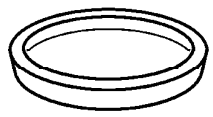

9168 GOLD
FITS 1" BASE
9169 NATURAL
FITS 1" BASE
9170 GOLD
FITS 1-3/8" BASE
9171 NATURAL
FITS 1-3/8" BASE

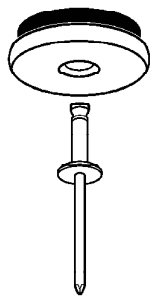

FOR SLED BASE CHAIRS

9188
7/8" PLATED STEEL BASE
INCLUDES RIVET

SNAP-IN INSERTS FOR WROUGHT IRON FURNITURE

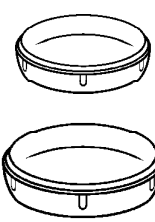

9178 FITS 1-7/32 ID
9179 FITS 1-1/2" ID

DUE TO DIFFERENCES IN GAUGE OF TUBING,
PLEASE SUPPLY US WITH YOUR
SAMPLE OF THESE GLIDES

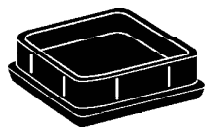
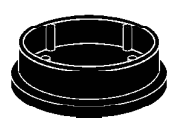

SLED GLIDE

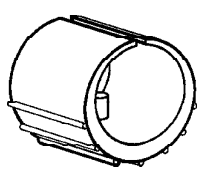

1/4" POST HOLDS GLIDE IN PLACE. FITS 3/4" THRU 1-1/4" BREWER AND "S" CHAIRS. SNAPS OVER TUBING.

9172 WHITE
9173 BLACK

SELF ADHESIVE SOFT CARPET GLIDE

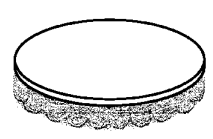

9162 7/8" BASE
9163 1-1/4" BASE

PROTECTS VINYL AND HARDWOOD FLOORS

WROUGHT IRON CAP

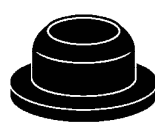

9164 FITS 1/2" ROD
1" BASE
9165 FITS 5/8" ROD
1-1/4" BASE

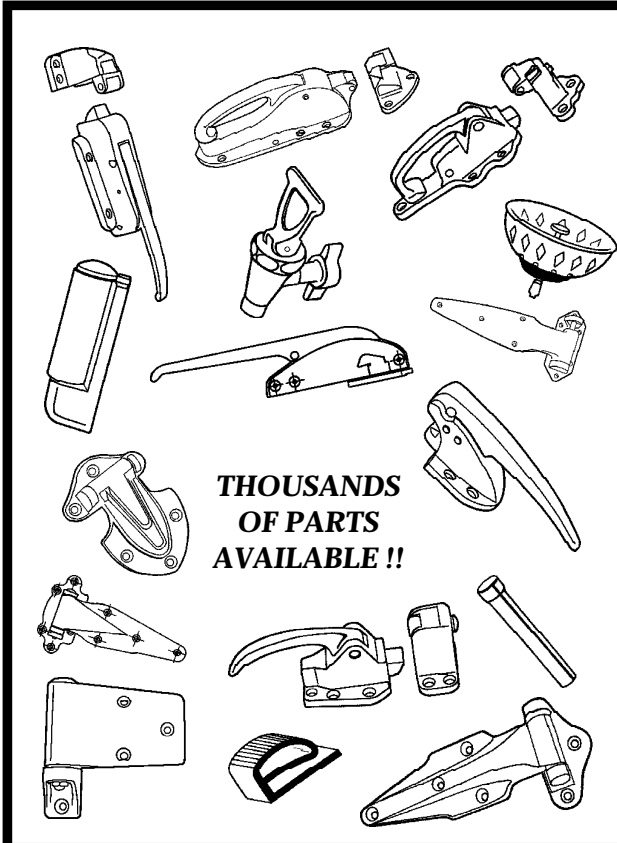

**THOUSANDS
OF PARTS
AVAILABLE !!**



**CALL FOR
OUR
HANDICAPPED
MAGAZINE !**

ENTRANCE

**RESERVED
PARKING**

**THAT HARD
TO FIND
PART IS**

**Right
Here!**

IN SHARPSBURG !

EQUIPARTS

**BRING A SAMPLE
COMMERCIAL - RESIDENTIAL - INSTITUTIONAL**

**WINDOW PARTS
PLUMBING PARTS
CHAIR & TABLE TIPS**

781-9100 817 MAIN ST. SHARPSBURG 15215
 BETWEEN HIGHLAND PARK & 62ND ST. BRIDGES OFF ROUTE 28
 HOURS: MON-FRI 8:30-5 SAT 8:30-NOON